



Solis RHI-5G Series Hybrid Inverter

Instruction Manual

Ver 1.5

Ginlong Technologies Co., Ltd.
No. 57 Jintong Road, Binhai Industrial Park, Xiangshan, Ningbo,
Zhejiang, 315712, P.R.China.
Tel: +86 (0)574 6578 1806
Fax: +86 (0)574 6578 1606
Email: info@ginlong.com
Web: www.ginlong.com

Please adhere to the actual products in case of any discrepancies in this user manual.
If you encounter any problem on the inverter, please find out the inverter S/N
and contact us, we will try to respond to your question ASAP.



Ginlong Technologies Co., Ltd.

1. Introduction	2
1.1 Product Description	2
1.2 Packaging	3
2. Safety & Warning	4
2.1 Safety	4
2.2 General Safety Instructions	4
2.3 Notice For Use	6
3. Overview	7
3.1 Screen	7
3.2 Keypad	7
3.3 Terminal Connection	7
4. Installation	8
4.1 Select a Location for the Inverter	8
4.2 Mounting the Inverter	10
4.3 PV Input Terminal Assembly	12
4.4 Battery Terminal Components	13
4.5 Assembling the AC Connector	14
4.6 Meter Installation	16
4.7 Communication Cable Assembly	18
4.8 External ground connection	19
4.9 Logic interface connection	20
4.10 Inverter monitoring connection	21
4.11 LED Indicates	22
5. Operation	23
5.1 Initial Display	23
5.2 Main Menu	25
5.3 Information	25
5.4 Settings	28
5.5 Advanced Info	30
5.6 Advanced Settings - Technicians Only	35
5.7 AFCI function	50
6. Commissioning & Shutdown	52
7. Maintenance	53
8. Troubleshooting	54
9. Specifications	59
10. Appendix	68

1. Introduction

1.1 Product Description

The Solis RHI-5G Series is designed for residential hybrid systems, which can work with batteries to optimize self-consumption. The unit can operate in both off- and on-grid modes.

The Solis RHI-5G Series has 5 different models:

RHI-3K-48ES-5G, RHI-3.6K-48ES-5G, RHI-4.6K-48ES-5G, RHI-5K-48ES-5G, RHI-6K-48ES-5G

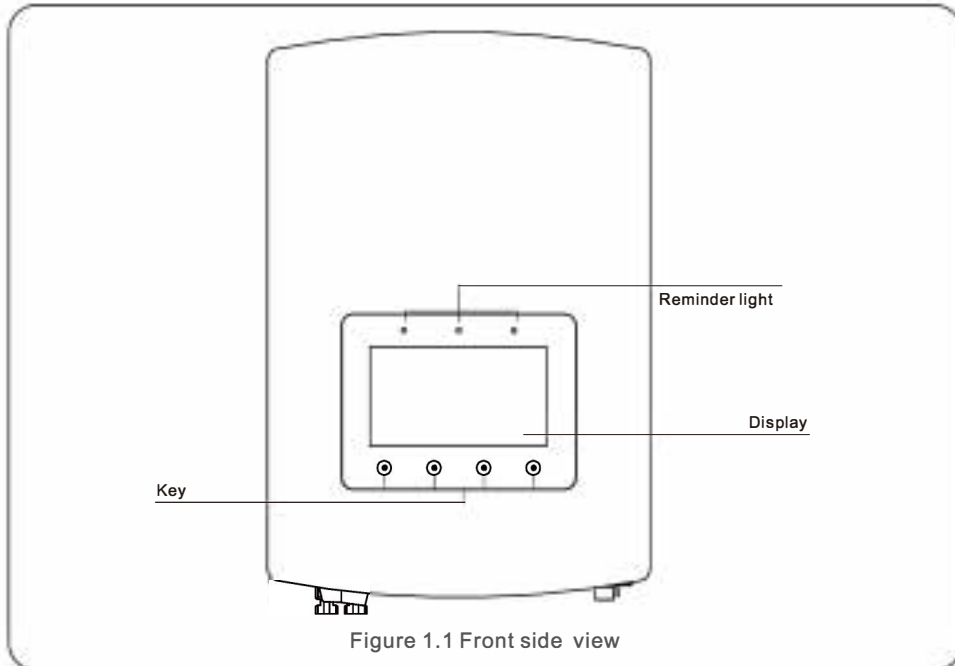

Figure 1.1 Front side view

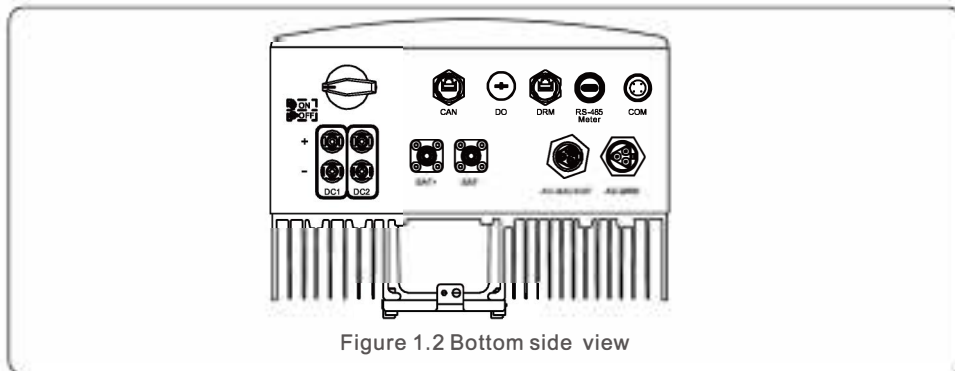
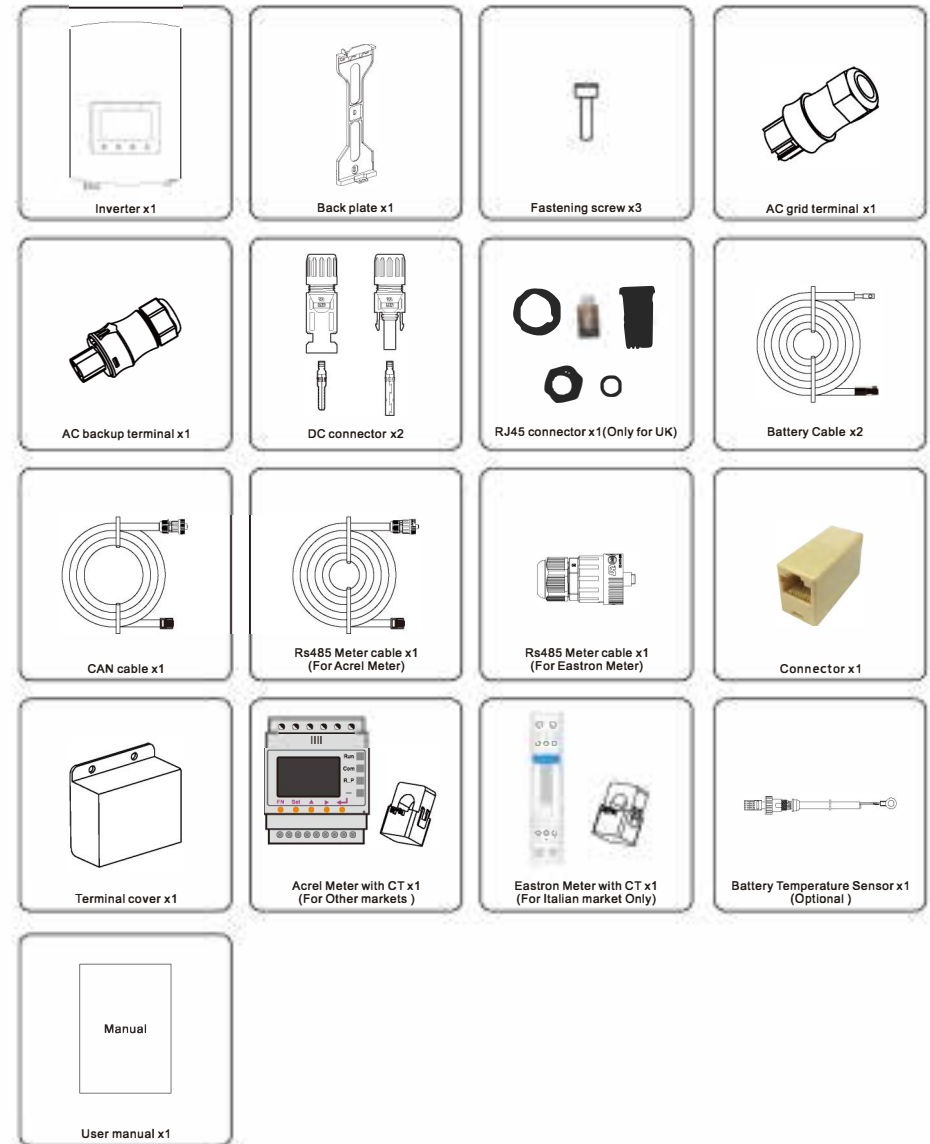

Figure 1.2 Bottom side view

1. Introduction

1.2 Packaging

Please ensure that the following items are included in the packaging with your machine:



If anything is missing, please contact your local Solis distributor.

2. Safety & Warning

2.1 Safety

The following types of safety instructions and general information appear in this document as described below:

**DANGER:**

“Danger” indicates a hazardous situation which if not avoided, will result in death or serious injury.

**WARNING:**

“Warning” indicates a hazardous situation which if not avoided, could result in death or serious injury.

**CAUTION:**

“Caution” indicates a hazardous situation which if not avoided, could result in minor or moderate injury.

**NOTE:**

“Note” provides tips that are valuable for the optimal operation of your product.

2.2 General Safety Instructions

**WARNING:**

Only devices in compliance with SELV (EN 69050) may be connected to the RS485 and USB interfaces.

**WARNING:**

Please don't connect PV array positive (+) or negative (-) to ground, it could cause serious damage to the inverter.

**WARNING:**

Electrical installations must be done in accordance with the local and national electrical safety standards.

**WARNING:**

Do not touch any inner live parts until 5 minutes after disconnection from the utility grid and the PV input.

2. Safety & Warning

**WARNING:**

To reduce the risk of fire, over-current protective devices (OCPD) are required for circuits connected to the inverter. The DC OCPD shall be installed per local requirements. All photovoltaic source and output circuit conductors shall have isolators that comply with the NEC Article 690, Part II. All Solis single phase inverters feature an integrated DC switch.

**CAUTION:**

Risk of electric shock, do not remove cover. There is no user serviceable parts inside, refer servicing to qualified and accredited service technicians.

**CAUTION:**

The PV array supplies a DC voltage when they are exposed to sunlight.

**CAUTION:**

Risk of electric shock from energy stored in capacitors of the Inverter, do not remove cover for 5 minutes after disconnecting all power sources (service technician only). Warranty may be voided if the cover is removed without authorization.

**CAUTION:**

The surface temperature of the inverter can reach up to 75°C (167 F). To avoid risk of burns, do not touch the surface of the inverter while it's operating. Inverter must be installed out of the reach of children.

**NOTE:**

PV module used with inverter must have an IEC 61730 Class A rating.

**WARNING:**

Operations below must be accomplished by licensed technician or Solis authorized person.

**WARNING:**

Operator must put on the technicians' gloves during the whole process in case of any electrical hazards.

**WARNING:**

AC-BACKUP of RHI-5G Series is forbidden to connect to the grid.

2. Safety & Warning

WARNING:
The RHI-5G Series does not support parallel (three- and single-phase) operation on the AC-BACKUP port. Parallel operation of the unit will void the warranty.

WARNING:
Please refer to the specification of the battery before configuration.

2.3 Notice For Use

The inverter has been constructed according to the applicable safety and technical guidelines. Use the inverter in installations that meet the following specifications ONLY:

1. Permanent installation is required.
2. The electrical installation must meet all the applicable regulations and standards.
3. The inverter must be installed according to the instructions stated in this manual.
4. The inverter must be installed according to the correct technical specifications.

3. Overview

3.1 Screen

Solis RHI-5G Series adopts 7 inch color screen, it displays the status, operating information and settings of the inverter.

3.2 Keypad

There are four keys in the front panel of the inverter (from left to right): ESC, UP, DOWN and ENTER keys. The keypad is used for:

- Scrolling through the displayed options (the UP and DOWN keys);
- Access and modify the settings (the ESC and ENTER keys).



Figure 3.2 Keypad

3.3 Terminal Connection

Solis RHI-5G Series inverter is different from normal on-grid inverter, please refer to the instructions below before start connection.

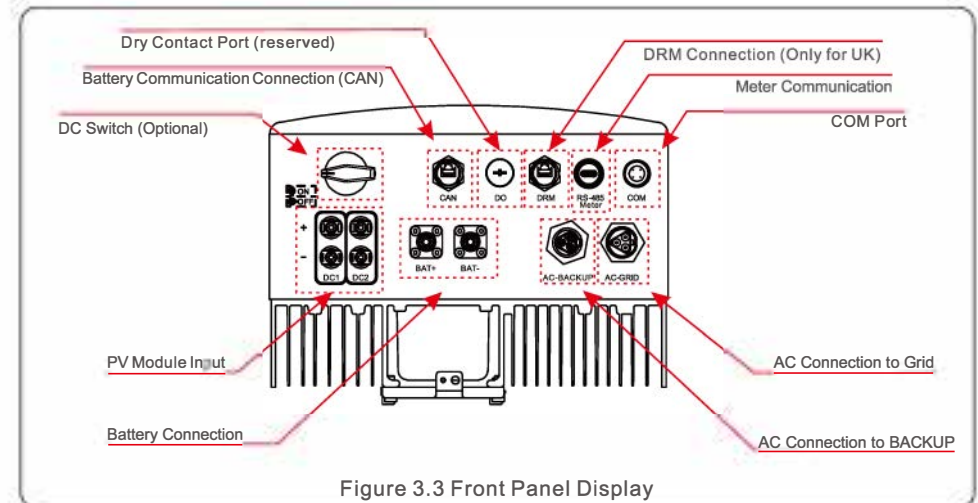

Figure 3.3 Front Panel Display



WARNING:

Please refer to the specification of the battery before configuration.

4. Installation

4.1 Select a Location for the Inverter

To select a location for the inverter, the following criteria should be considered:

- Exposure to direct sunlight may cause output power derating. It is recommended to avoid installing the inverter in direct sunlight.
- It is recommended that the inverter is installed in a cooler ambient which doesn't exceed 104F/40C.

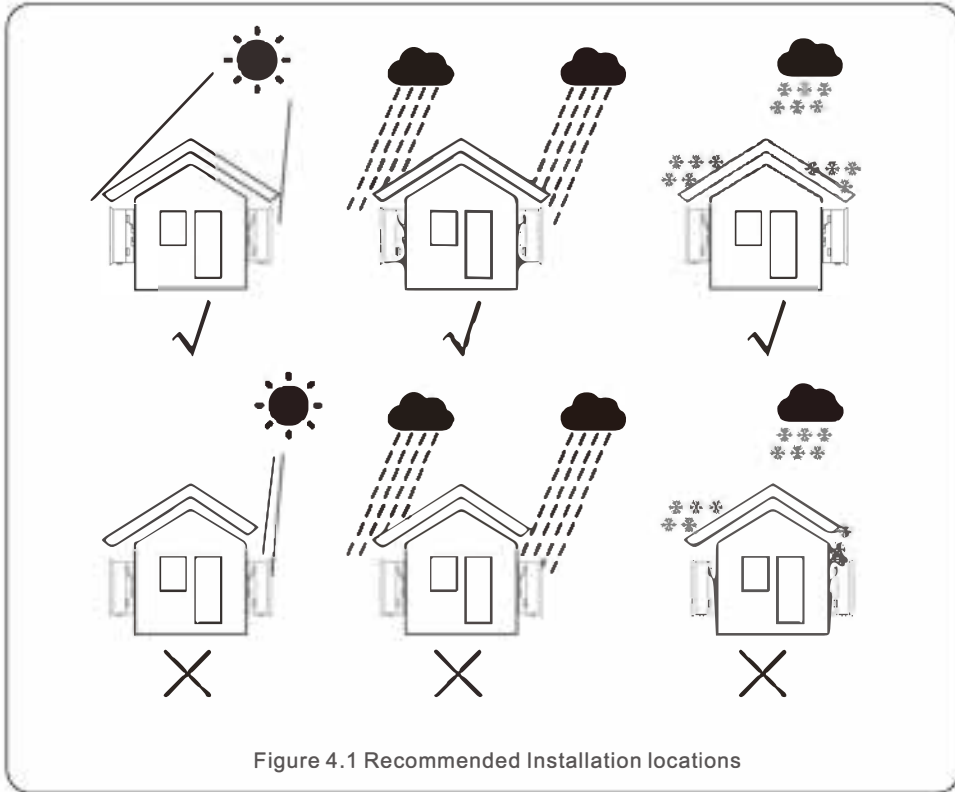

WARNING: Risk of fire

Despite careful construction, electrical devices can cause fires.

- Do not install the inverter in areas containing highly flammable materials or gases.
- Do not install the inverter in potentially explosive atmospheres.

4. Installation

- Install on a wall or strong structure capable of bearing the weight of the machine (17kg).
- Install vertically with a maximum incline of +/- 5 degrees, exceeding this may cause output power derating.
- To avoid overheating, always make sure the flow of air around the inverter is not blocked. A minimum clearance of 300mm should be kept between inverters or objects and 500mm clearance between the bottom of the machine and the ground.

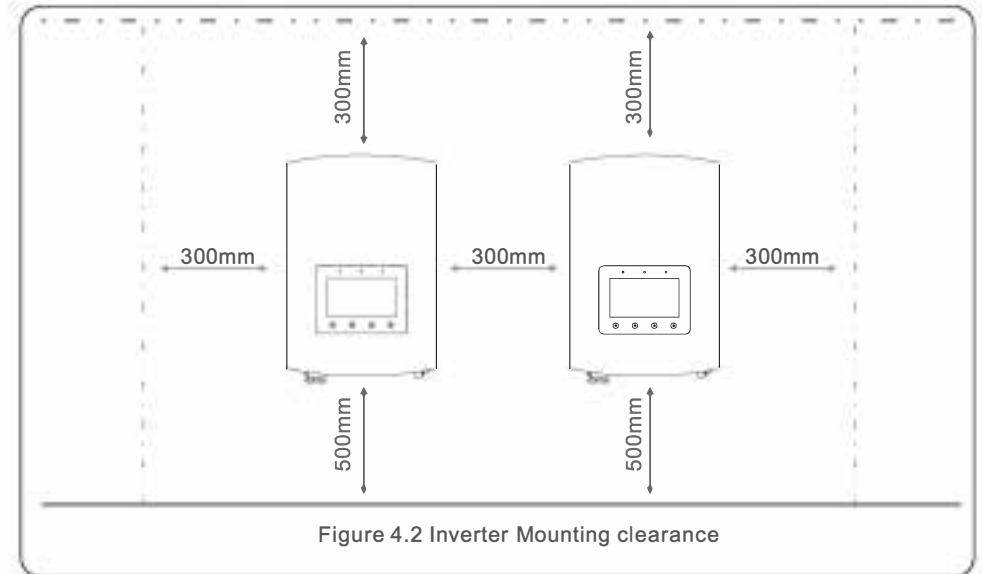

- Visibility of the LEDs and LCD should be considered.
- Adequate ventilation must be provided.



NOTE:

Nothing should be stored on or placed against the inverter.

4. Installation

4.2 Mounting the Inverter

Dimensions of mounting bracket:

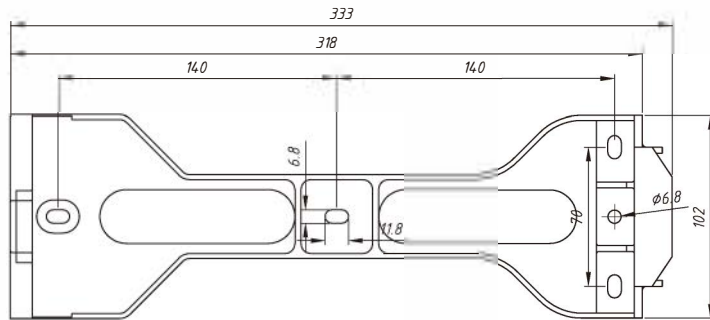

Figure 4.3 Inverter wall mounting

Once a suitable location has been found accordingly to 4.1 using figure 4.3 and figure 4.4 mount the wall bracket to the wall.

The inverter shall be mounted vertically.

The steps to mount the inverter are listed below:

1. Select the mounting height of the bracket and mark the mounting holes.
For brick walls, the position of the holes should be suitable for the expansion bolts.

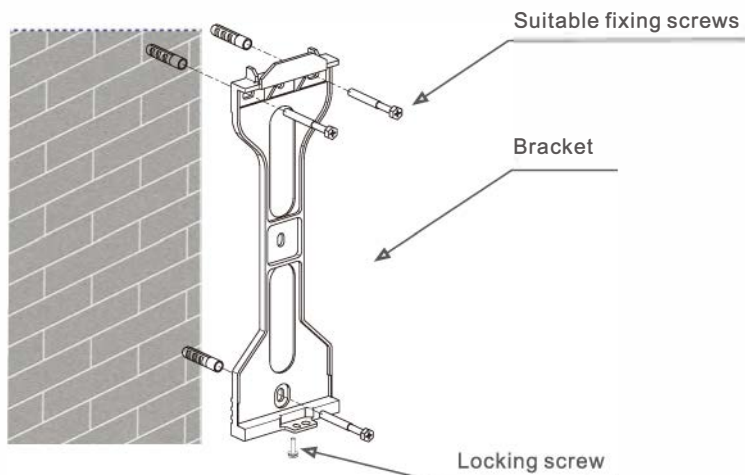

Figure 4.4 Fix bracket on the wall

4. Installation



WARNING:

The inverter must be mounted vertically.

2. Lift up the inverter (be careful to avoid body strain), and align the back bracket on the inverter with the convex section of the mounting bracket. Hang the inverter on the mounting bracket and make sure the inverter is secure (see Figure 4.5)

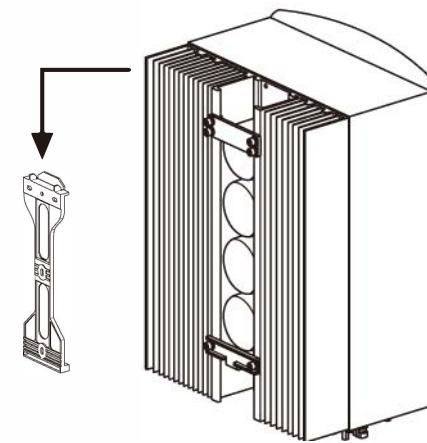

Figure 4.5 Wall Mount Bracket

4. Installation

4.3 PV Input Terminal Assembly

Please ensure the following before connecting the inverter:

- Make sure the voltage of the PV string will not exceed the max DC input voltage (600Vdc).
Violating this condition will void the warranty.
- Make sure the polarity of the PV connectors are correct.
- Make sure the DC-switch, battery, AC-BACKUP, and AC-Grid are all in their off-states.
- Make sure the PV resistance to ground is higher than 20K ohms.

The Solis RHI-5G Series inverter uses the MC4 connectors.

Please follow the picture below to assemble the MC4 connectors.

PV wire diameter requirements: 2.5~4mm².

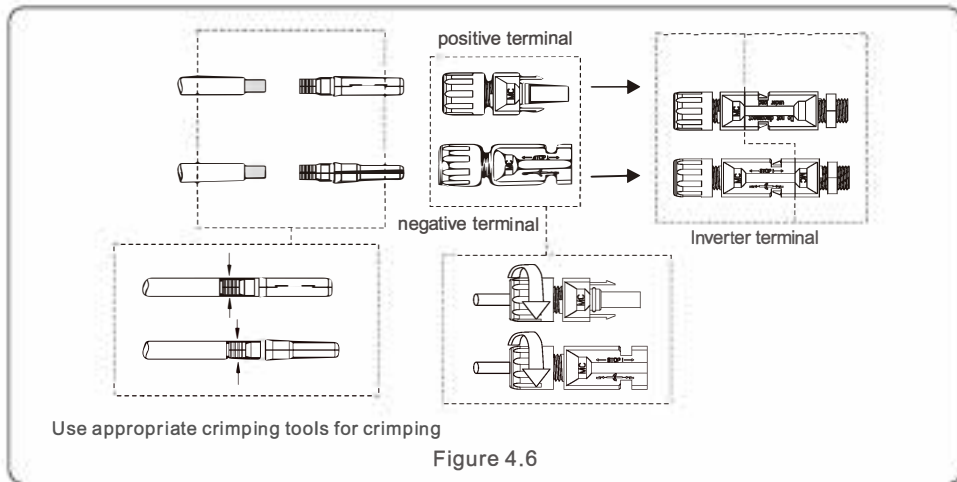

4. Installation

4.4 Battery Terminal Components

To avoid DC Arc, Solis recommends installing DC switch between batteries and Hybrid Inverter.

- Ensure the correct polarity of batteries before connecting to the inverter.



WARNING:

Power cables use water-proof AMPHENOL connectors. When pull out the power cable, you must press the button as indicated in the right figure.

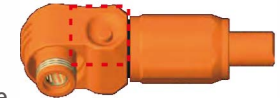

Connect the Battery cable to the inverter and make sure the positive and negative poles are correct. A "Click" sound means fully connection and fasten the cables with the terminal protection cover as indicated in Figure 4.7.

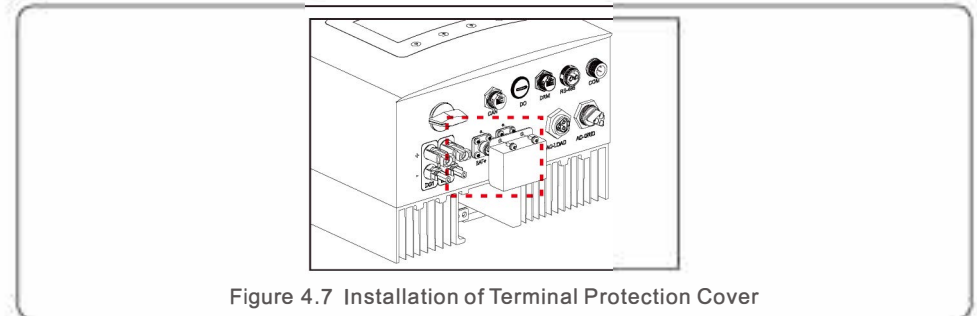

Note:

Before connecting the battery, please carefully read the user manual of the battery and perform the installation exactly as the battery manufacturer requests.

4. Installation

4.5 Assembling the AC Connector

There are two AC terminals and the assembly steps for both are the same.
Take out the AC connector parts from the packaging.

1. Make sure you use a cable within the correct specifications as shown in the image below.

Describe	Numerical value
Wire diameter	10~12mm
Traverse cross sectional area	2.5~6mm ²
Exposure Length	12mm

2. Lead the AC cable through the cable gland and the housing.

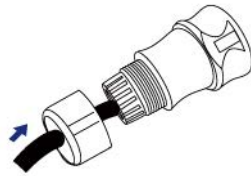

3. Remove a length of 40mm of the cable jacket and strip the wire insulation to a length of 8 – 15mm.

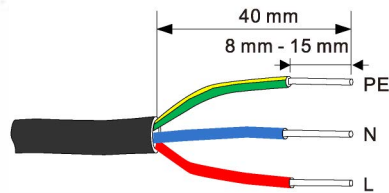

4. Installation

4. Each of the terminals are labeled. Ensure that the correct conductor is fastened (1.2 N.m. torque) to the correct terminal.

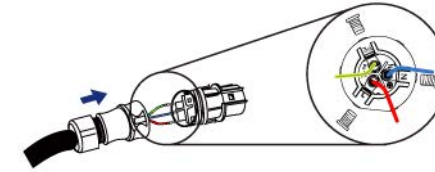

WARNING:

Observe the terminal layout of terminal block.
Do not connect the phase lines to "PE" terminal, otherwise the inverter will not function properly.

5. Make sure the rib of the terminal block and the groove on the housing engage perfectly until a "click" is heard to felt.

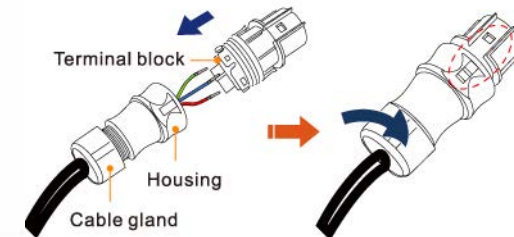

4. Installation

4.6 Meter Installation

Solis-RHI-(3-6)K-48ES-5G series inverter is able to connected Acrel meters or Eastron meters to fulfill the control logic of the self-consumption mode, export power control, monitoring, etc.

Acrel 1ph meter (With CT): ACR10R-D16TE

Acrel 3ph meter (With CT): ACR10R-D16TE4 (Optional)

Eastron 1ph meter (Direct Insert): SDM120M

Eastron 1ph meter (With CT): SDM120CTM (Optional)

Eastron 3ph meter (Direct Insert): SDM630M (Optional)

Eastron 3ph meter (With CT): SDM630MCT (Optional)

Below 4.6.1 section describes the connection diagram of the Acrel 1ph meter (With CT)

(Standard Accessory for all other market exclude Italy)

Below 4.6.2 section describes the connection diagram of the Eastron 1ph meter

(Direct Insert) (Standard Accessory for Italian market)

4.6.1 Single phase meter installation

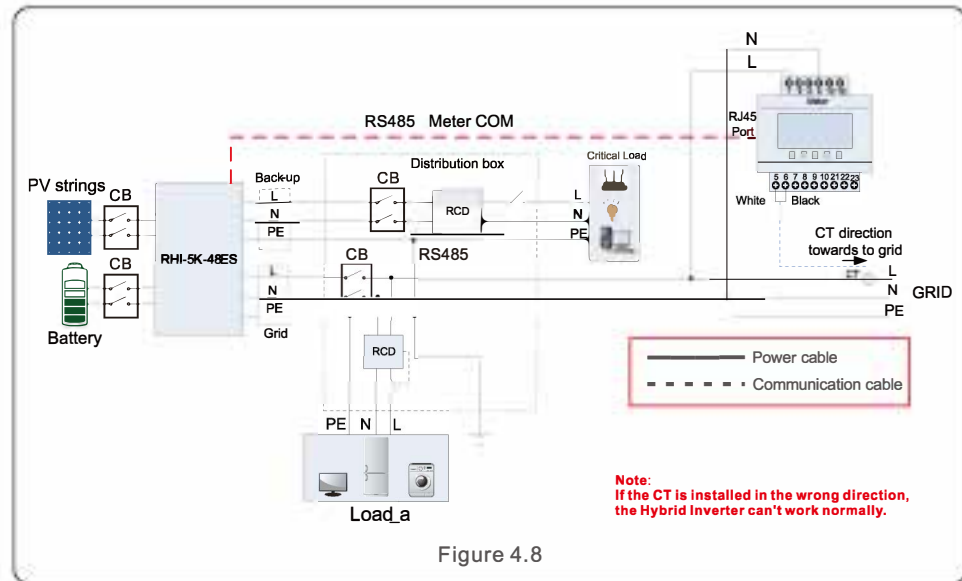

4. Installation

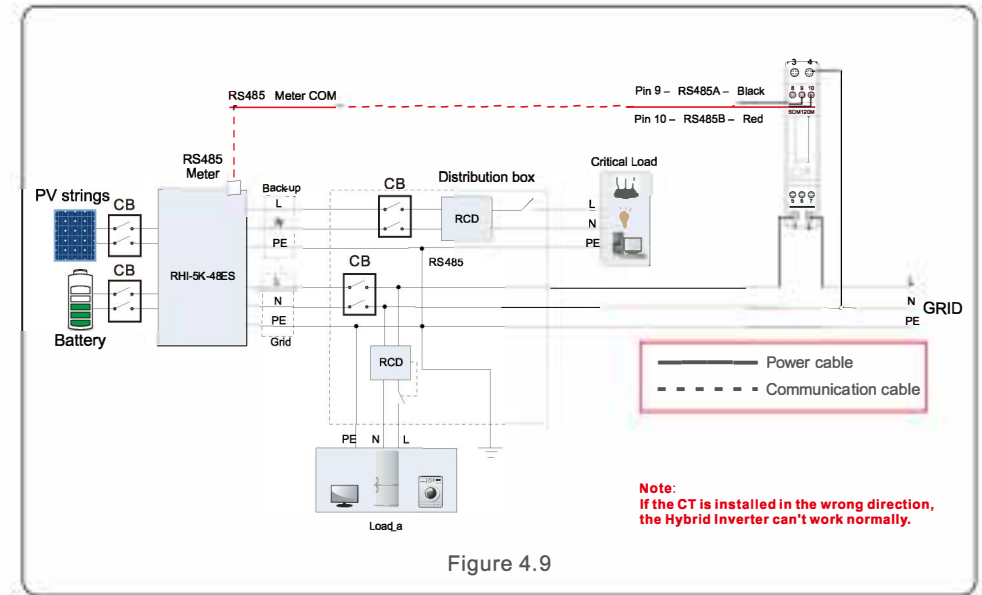

4. Installation

4.7 Communication Cable Assembly

The RHI-5G Series inverter uses RS485 cable to communicate with the Meter and CAN to communicate with the battery's BMS. The image below shows the assembly of the RS485/CAN communication cables.

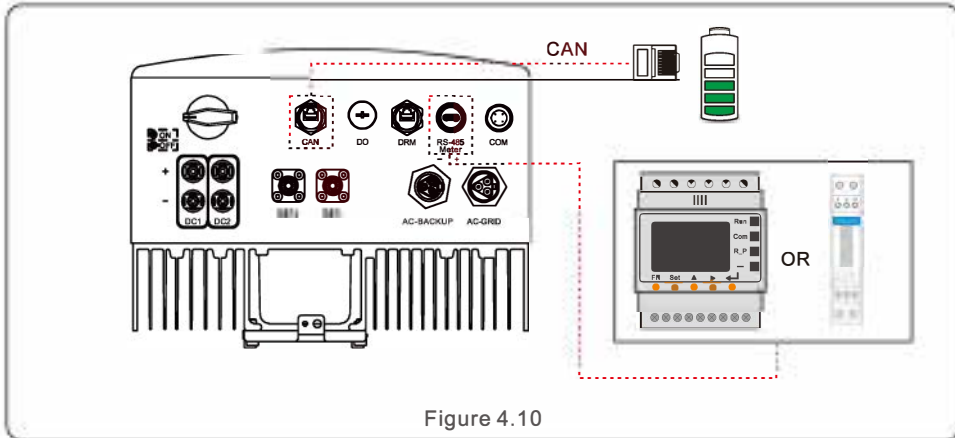

Figure 4.10



NOTE:

The CAN cable enables the communication between the inverter and Lithium batteries.

Procedure for connecting the CAN cable:

1. Take out the CAN cable (terminal marks 'CAN' on one end and 'to Battery' on the other end).
2. Unscrew the swivel nut from CAN port.
3. Insert the RJ45 terminal with CAN label into the CAN port, then fasten the swivel nut.
4. Connect the other end to the battery.



NOTE:

Lead-Acid and other older-technology battery types require experienced and precise design, installation and maintenance to work effectively. For RHI series inverters there is no temperature compensation, thus client need BTS (battery temperature sensor) which is connected to CAN port at one side and battery negative pole at the other side. BTS is optional. For further information please contact the sales manager. For lead-acid battery, battery SOC calculation may not be accurate according to battery in conformity between cells, battery aging or other specifications of lead-acid battery etc.

4. Installation



NOTE:

For CAN cable pin 4 (blue) and pin 5 (white-blue) are used for the communication.

Procedure for connecting the RS485 cable:

1. Take out the RS485 cable (terminal marks 'RS485' on one end and 'to Meter' on the other end).
2. Unscrew the swivel nut from RS485 port.
3. Insert the Two-pin terminal with RS485 label into the RS485 port, then fasten the swivel nut.
4. Connect the other end to the Meter.

4.8 External ground connection

An external ground connection is provided at the right side of inverter.

Prepare OT terminals: M4. Use proper tooling to crimp the lug to the terminal.

Connect the OT terminal with ground cable to the right side of inverter. The torque is 2Nm.

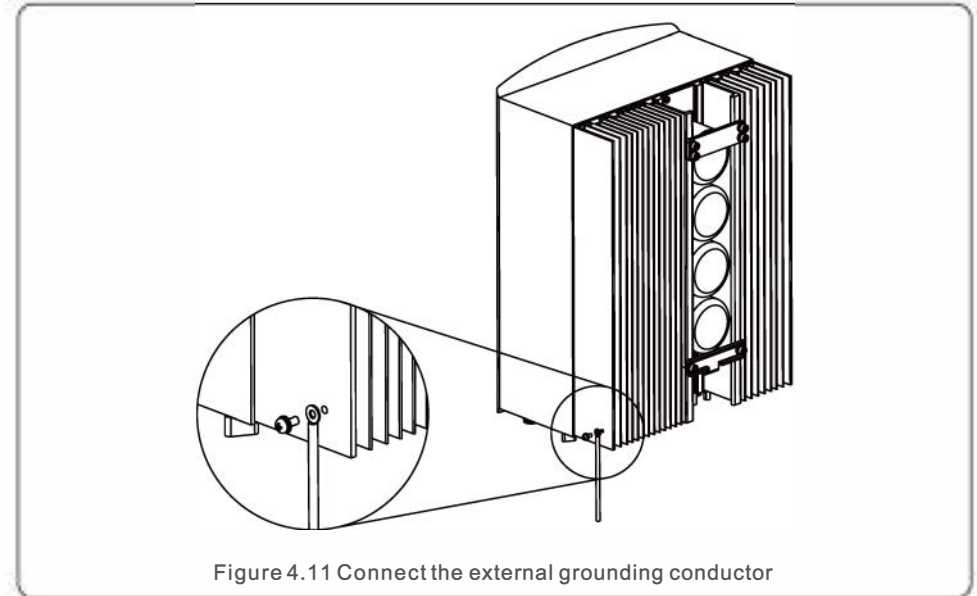

Figure 4.11 Connect the external grounding conductor

4. Installation

4.9 Logic interface connection

Logic interface is required by some local regulations that can be operated by a simple switch or contactor(Not available in South Africa).

When the switch is closed the inverter can operated normally. When the switch is opened, the inverter will reduce it's output power to zero within 5s.

Pin5 and Pin6 of RJ45 terminal is used for the logic interface connection.

Please follow below steps to assemble RJ45 connector.

1.Insert the network cable into the communication connection terminal of RJ45.



Figure 4.12 RJ45 communication connection terminals

2.Use the network wire stripper to strip the insulation layer of the communication cable. According to the standard line sequence of figure 4.13 connect the wire to the plug of RJ45, and then use a network cable crimping tool to make it tight.

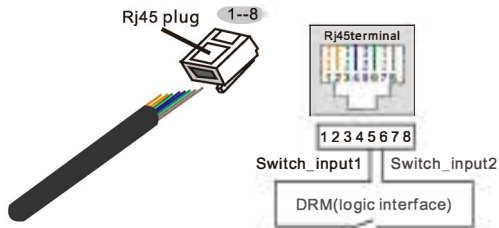

Figure 4.13 Strip the insulation layer and connect to RJ45 plug

3.Connect RJ45 to DRM (logic interface) .



NOTE:

To use this function, please contact the manufacturer.

4. Installation

4.10 Inverter monitoring connection

The inverter can be monitored via Wi-Fi or GPRS. All Solis communication devices are optional. For connection instructions, please refer to the Solis Monitoring Device installation manuals.

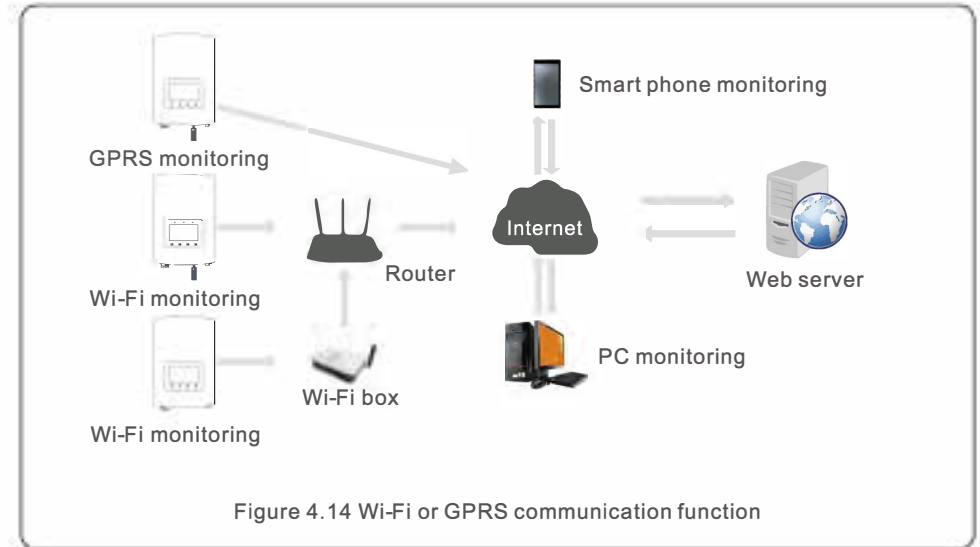

Figure 4.14 Wi-Fi or GPRS communication function

4. Installation

4.11 LED Indicates

There are three LED indicators on the RHI inverter (Red, Green, and Orange) which indicate the working status of the inverter.



Light	Status	Description
POWER	ON	The inverter can detect DC power.
	OFF	No DC power.
OPERATION	ON	The inverter is fully operational.
	OFF	The inverter has stopped operating.
	FLASHING	The inverter is initializing.
ALARM	ON	Fault condition is detected.
	OFF	No fault condition detected.
	FLASHING	Either the grid or solar cannot be detected.

Table 4.1 Status Indicator Lights

5. Operation

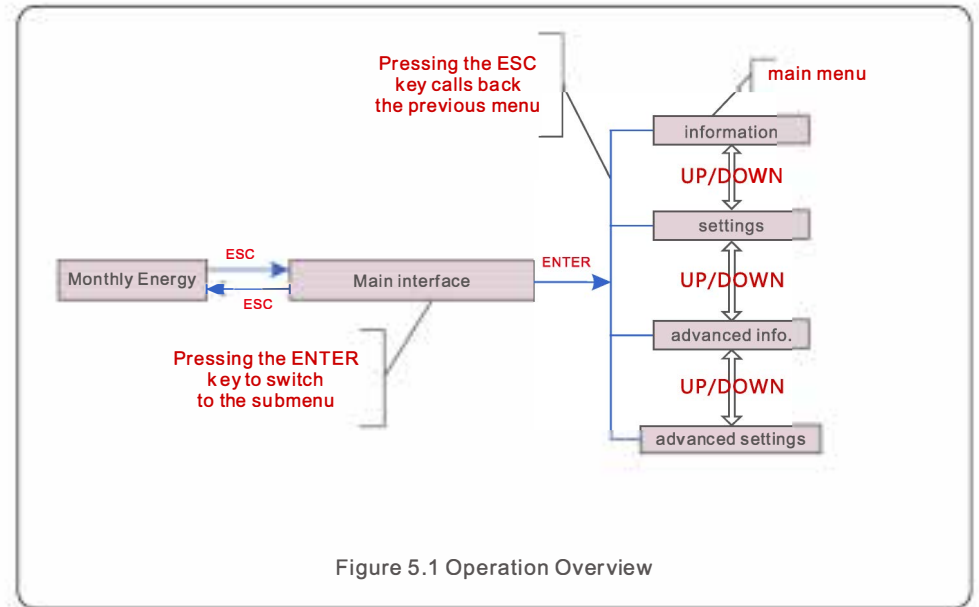

Figure 5.1 Operation Overview

5.1 Initial Display

When powering up the inverter for the first time, it is required to set the language. Press "ENT" to select.



Figure 5.2 Set Language

After setting the language, press "ESC" to access the main page.

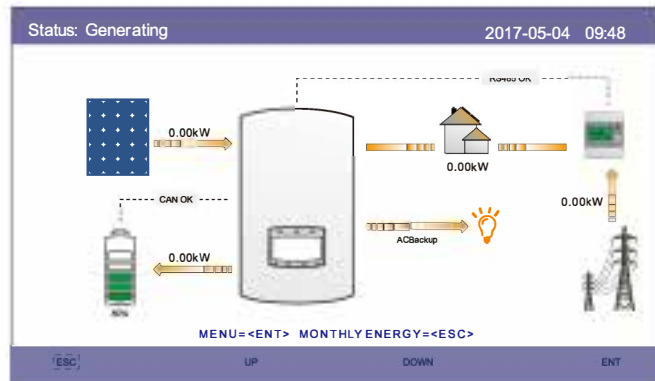

Figure 5.3 Main Page

On the main page,

Press "ESC" : View the yield data on a monthly bar charts. Then use "UP" and "DOWN" to change the date and "ENT" to move the cursor.

Press "UP" or "DOWN": View different status on the top left of the main page.

Press "ENT": Enter the main menu.

	Solar Power: When solar power is generated , an arrow indicates the direction of the power flow and the value is shown above the arrow.
	Battery: When the battery is connected successfully, it will display "CAN OK", meanwhile, battery SOC, arrow and value of power flow is shown. Otherwise, it will display "CAN Fail".
	Non-Critical Loads: Loads connected to the AC Grid port which will shutdown if the grid is in malfunction.
	Smart Meter: When the smart meter is connected successfully, it will display "RS485 OK", otherwise "RS485 Fail".
	Critical Loads: Loads connected to the AC Backup port which will be supported by battery and solar even if the grid is in malfunction.
	Grid: The arrow and value indicate the export/import power of the hybrid system.

5.2 Main Menu

There are four submenu in the Main Menu:

1. Information
2. Settings
3. Advanced Information
4. Advanced Settings

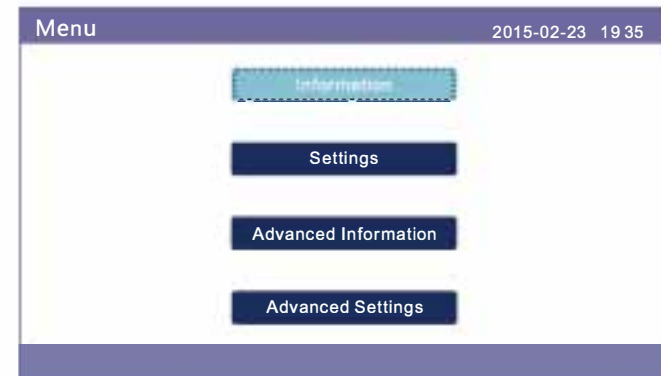

Figure 5.4 Main Menu

5.3 Information

In the "Information" section, operating data and information can be viewed.

Three pages of information can be checked by press "UP" or "DOWN".

The example display is shown in the following Figure 5.5, 5.6 and 5.7.

Values are for reference only.

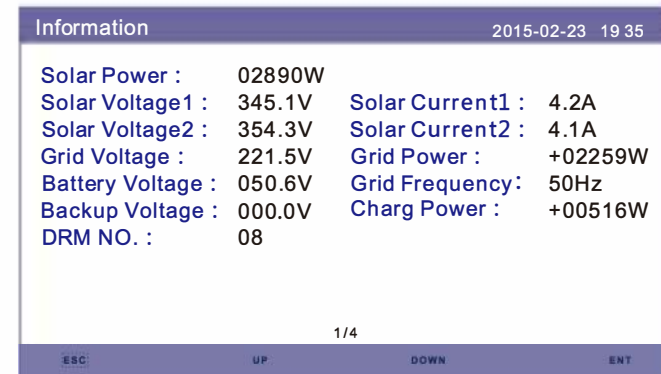

Figure 5.5 Information Page 1

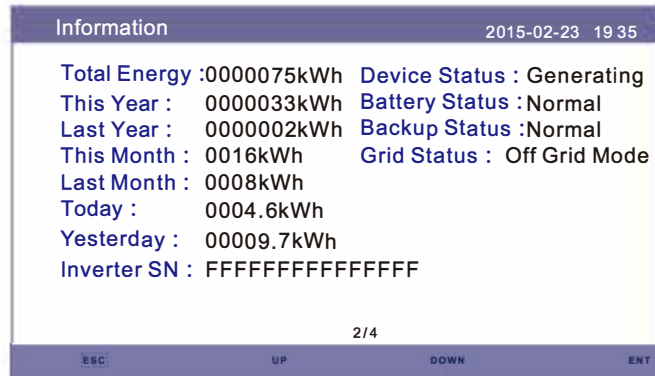

Figure 5.6 Information Page 2

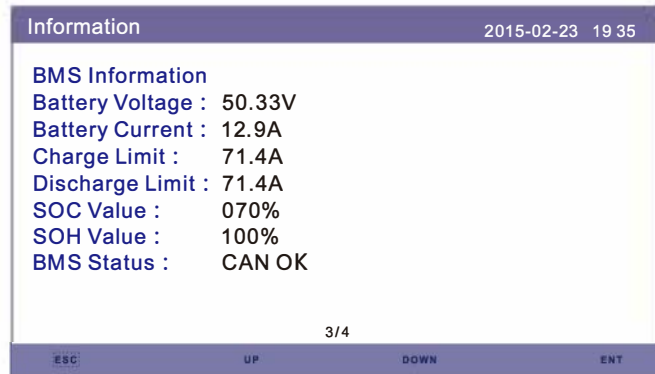

Figure 5.7 Information Page 3

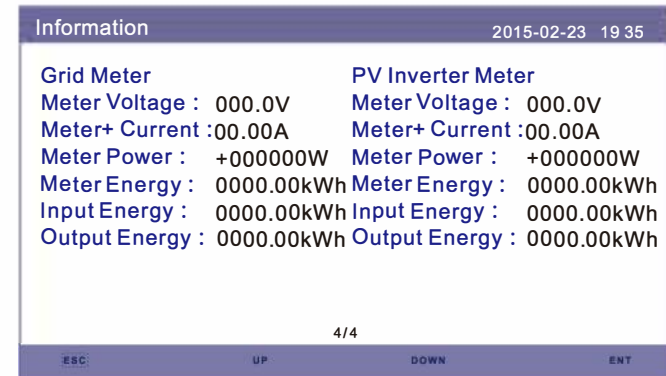

Figure 5.8 Information Page 4



NOTE:

Meter Power/Grid Power: Positive value indicates exporting power to the grid, negative value indicates importing power from the grid
 Charge Power: Positive value indicates charging, negative value indicates discharging.



NOTE:

Information for "PV Inverter Meter" is only available when two Eastron meters are used and Meter Placement is selected as "Grid+PV Meter".
 Details please consult Solis service department.

5. Operation

5. Operation

5.4 Settings

In the "Settings" section, Time/Date, Slave address and language can be modified.



Figure 5.9 Setting

5.4.1 Set Time/Date

Set the time and date on the inverter. Must set this according to local time as it affects the daily yield calculation. (If Solis monitoring system is used, must set the correct time zone of the system, otherwise datalogger will update the inverter time based on the time zone of the system.)

Press "UP" and "DOWN" to change the value.

Press "ENT" to move the cursor.

Press "ESC" to save the change.

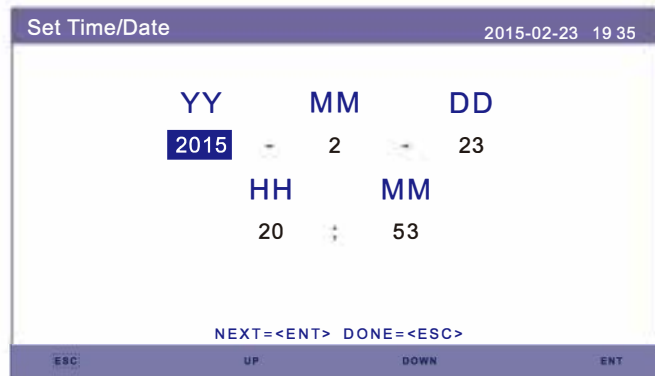

Figure 5.10 Set Time

5.4.2 Set Address

Set the slave address of the inverter. The default address is 01.

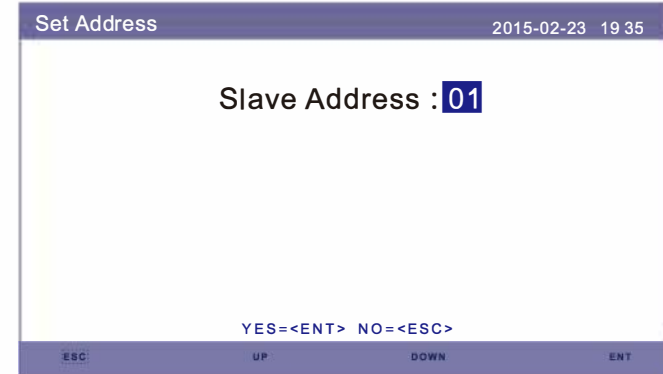

Figure 5.11 Set Address

5.4.3 Set Language

Set system language. Chinese and English are available.



Figure 5.12 Set Language

5. Operation

5. Operation

5.5 Advanced Information

Detailed information can be viewed in this section:

1. Alarm Message
2. Running Message
3. Version
4. Communication Data.
5. Daily Energy
6. Monthly Energy
7. Yearly Energy
8. Total Energy.
9. Warning Message

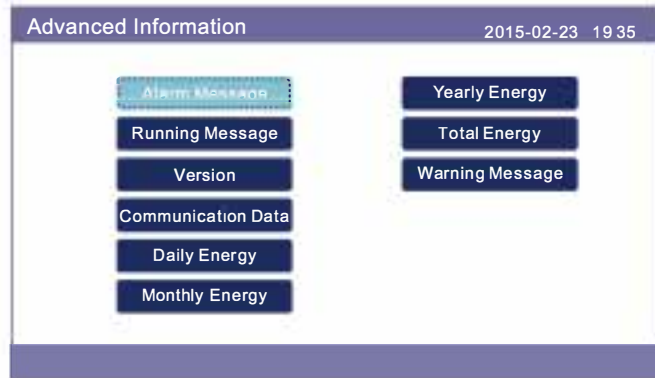

Figure 5.13 Advanced Information

5.5.1 Alarm Message

40 pages of latest alarm messages (5 per page). Alarm message shows the alarm that will lead to inverter shutdown.

Alarm Message		
Message	Date/Time	Date
NO-Grid	02-23 19:35	0000
NO-Grid	02-23 19:34	0000
NO-Grid	02-23 19:34	0000
NO-Grid	02-23 19:24	0000
NO-Grid	02-23 18:22	0000
01/40		

ESC UP DOWN ENT

Figure 5.14 Alarm Message

5.5.2 Running Message

This function is for maintenance person to get running message such as internal temperature, Standard NO. etc. (Values are for reference only.).

Running Message	
2015-02-23 19:35	
DC Bus Voltage :	410.7V
Reactive Power Ratio :	+1.00
Output Power Limit :	100%
Control Word Status :	0000H
Inverter Temperature :	+0031.6degC
Standard :	G59/3
Grid Filter NO. :	00
Ground Voltage :	000.0V
Battery Enable :	Disable

ESC

Figure 5.15 Running Message

5.5.3 Version

Inverter model number and software version can be viewed in this section. Values are for reference only..

Version	
2015-02-23 19:35	
Model :	F8
Software Ver. :	140000

ESC

Figure 5.16 Model Version and Software Version

5. Operation

5.5.4 Communication Data

Internal communication data can be viewed in this section. For maintenance person only. Values are for reference only.

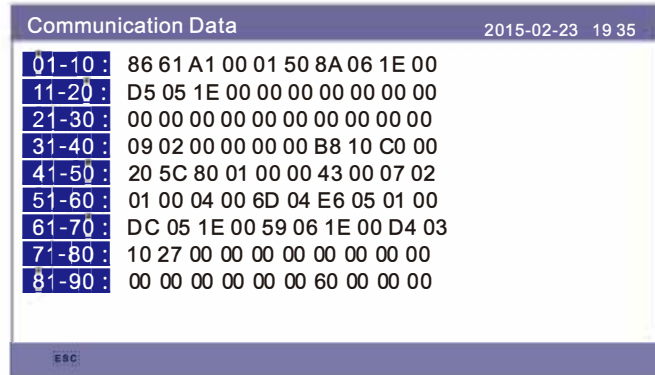

Figure 5.17 Communication Data

5.5.5 Daily Energy

The screen shows the daily energy detail of the inverter.

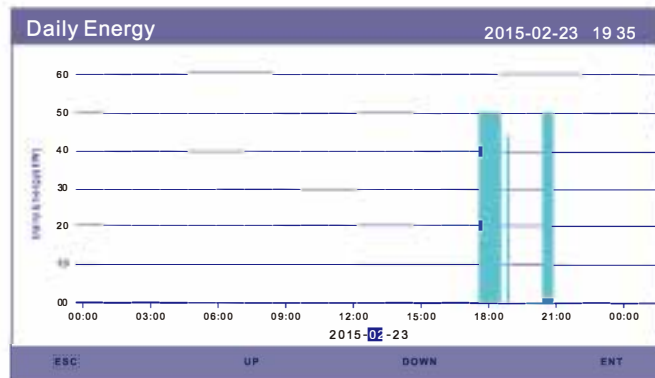

Figure 5.18 Daily Energy

5. Operation

5.5.6 Monthly Energy

The screen shows the inverter monthly energy detail of different month.

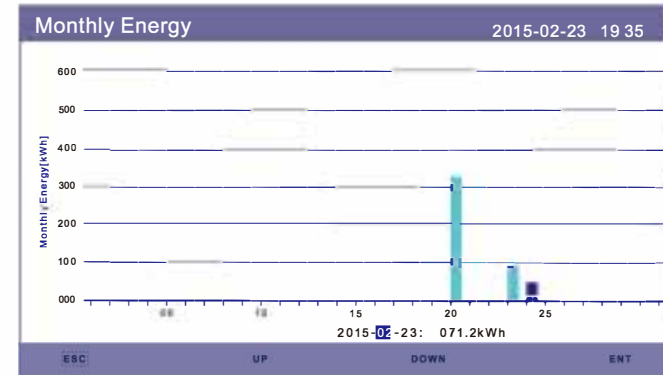

Figure 5.19 Monthly Energy

5.5.7 Yearly Energy

The screen shows the inverter yearly energy detail of different year.

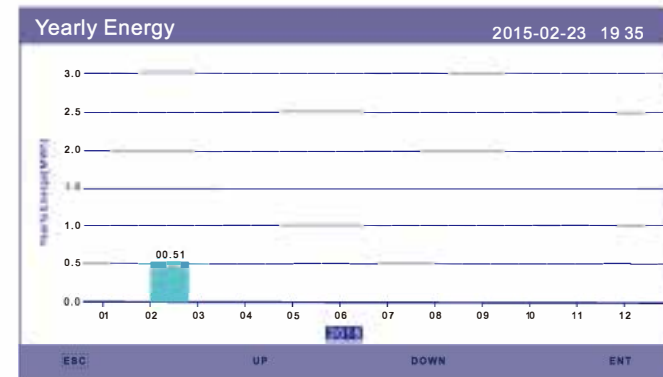

Figure 5.20 Yearly Energy

5. Operation

5.5.8 Total Energy

The screen shows the inverter total energy detail.

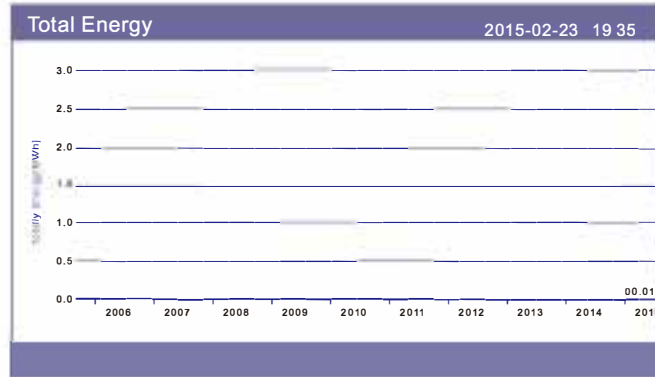

Figure 5.21 Total Energy

5.5.9 Warning Message

10 pages of latest warning messages (5 per page).

Warning message shows the warning that is abnormal but will not lead to inverter shutdown.



Figure 5.22 Warning Message

5. Operation

5.6 Advanced Settings - Technicians Only



NOTE:

This function is for authorised technicians only. Improper access and operation may result in abnormal results and damage to the inverter. Password required – restricted access – authorised technicians only. Un-authorized access may void the warranty. (Password"0010")

Select Advanced Settings from main menu, the LCD screen show the password is needed:

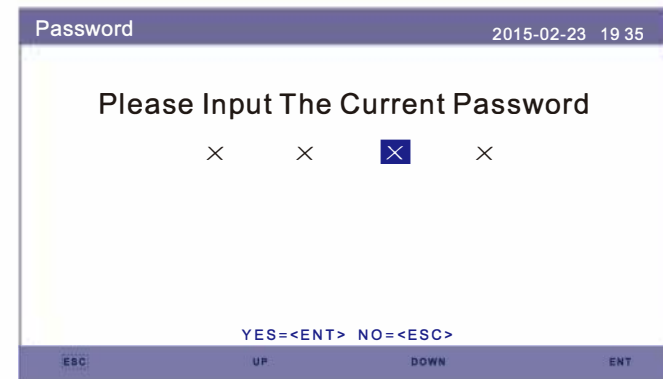

Figure 5.23 Enter Password

Press "DOWN" to move the cursor.

Press "UP" to change the number.

Press "ENT" to enter the restricted section.

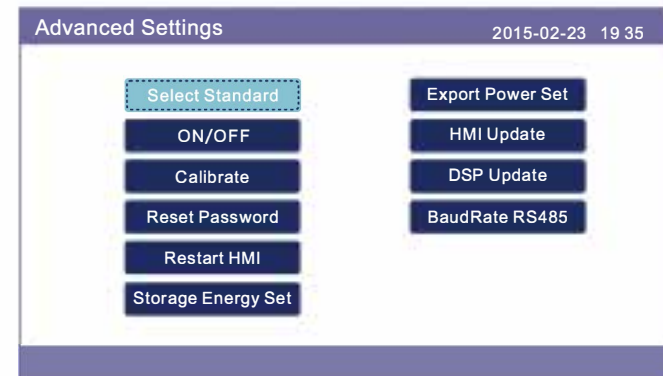

Figure 5.24 Advanced Settings

5. Operation

5.6.1 Select Standard

This function is used to select corresponding grid standards.
Please refer to the actual LCD setting for the grid standard options.



Figure 5.25 Select Standard

Press "UP" and "DOWN" to go through the list.
Press "ENT" to check the parameters, press "ENT" again to select the standard.

5.6.2 ON/OFF

This function is used to start or stop the generation of the inverter.

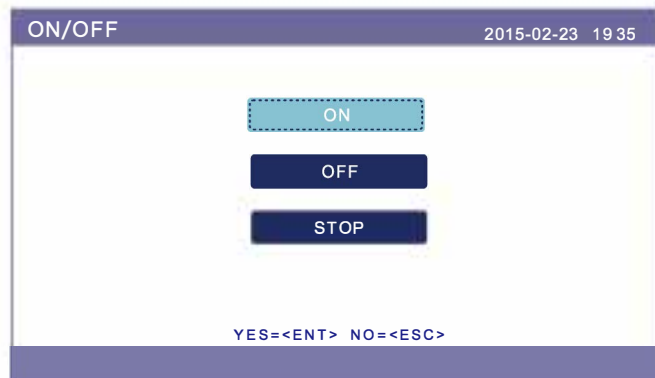

Figure 5.26 Set ON/OFF

5. Operation

5.6.3 Calibrate

Warranty or maintenance may result in resetting total generating data, this function allow the maintenance personnel to amend the total generating data of replacement inverter to the original one.

By using our data monitoring hardware, the data on monitoring website can automatically synchronize with the preset total generating power of inverter.

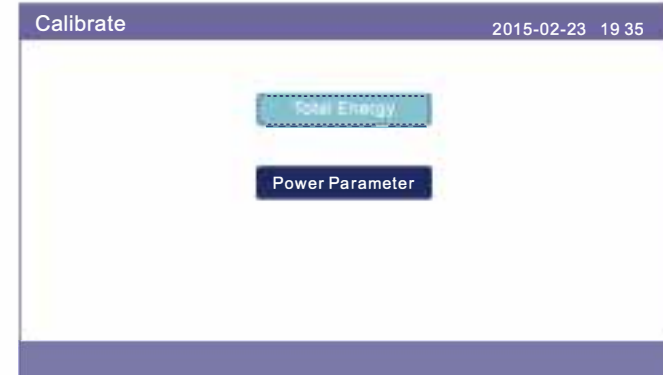

Figure 5.27 Calibrate

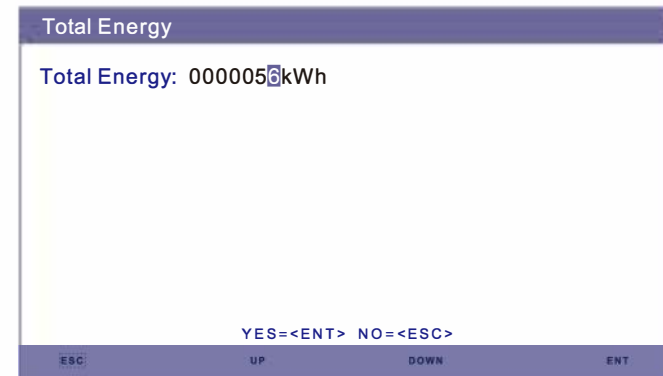

Figure 5.28 Total Energy

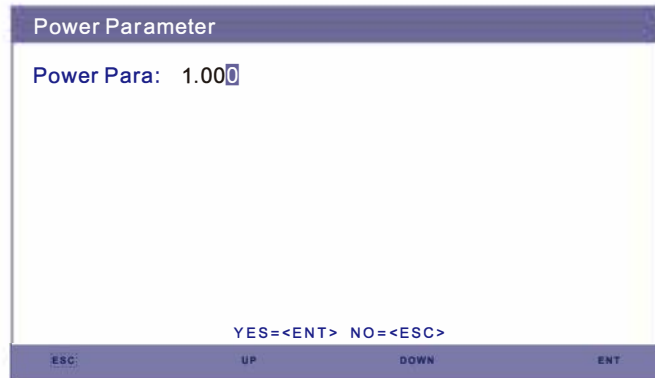

Figure 5.29 Power Parameter

5.6.4 Reset Password

Reset Password: In this page, user can reset the inverter password, but the admin password is always valid.



Figure 5.30 Reset Password

5.6.5 Restart HMI

This function is to reboot the LCD screen.

5.6.6 Storage Energy Set

This section contains working mode setting, battery control setting, etc.

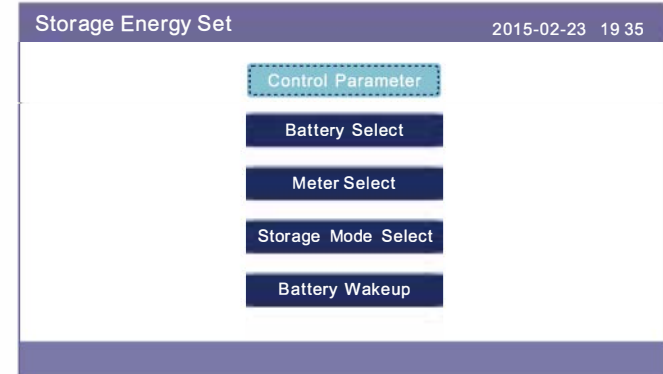

Figure 5.31 Storage Energy set

5.6.6.1 Control Parameter

Enter the Control Parameter menu as shown below:

Don't change the settings without the permission of technicians.

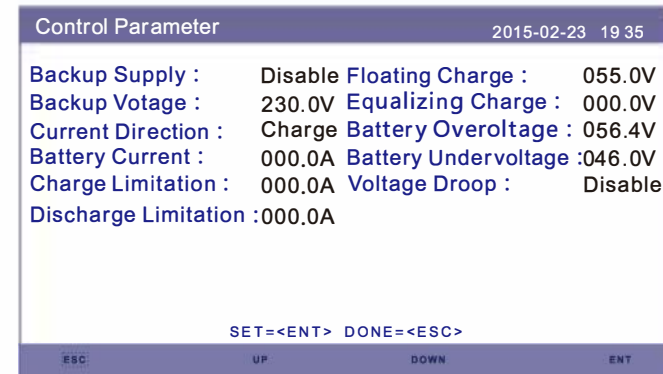

Figure 5.32 Control Parameter

5.6.6.2 Battery Select

This product is compatible with the following battery modules:

Brand	Model	Setting
BYD	Box Pro 2.5-13.8	Select "B-BOX"
LG Energy Solution	RESU 3.3/6.5/10/13 (CEI 0-21)	Select "LG Chem"
Pylontech	US2000(CEI 0-21)/US3000(CEI 0-21)/ ForceL1(CEI 0-21)/ForceL2(CEI 0-21)/ Phantom-S/US2000C/US3000C/UP5000	Select "Pylon"
Dyness	Powerdepot/Powerbox/B4850	Select "Dyness"
Puredrive	48V-100Ah	Select "Puredrive"
AOBOET	AOBOET Uhome-LFP 6.8kWh	Select "AoBo"
WECO	5K3-R20	Select "WECO"
Jiawei	Home E11	Select "Jiawei"
Soluna	4K PACK	Select "Soluna"
Highstar	HSD5870	Select "Highstar"
Freedom	Freedom Won Lite	Select "Freedom"
KODAK	FL5.2	Select "KODAK"
FOX	LV5200	Select "FOX"
UZ Energy	L051100-A	Select "CATL"
GSL	48V-100Ah	Select "GSL"
Zeta	51.2V-100Ah	Select "Zeta"



NOTE:

If hybrid inverter is not connected to a battery, select "No Battery" to avoid alarms.

For above compatible battery modules, Only two parameters need to be defined:

- * OverDischg SOC (10%~40%, default 20%)

- Inverter will not discharge the battery when the OverDischg SOC is reached.

Battery self-discharge is unavoidable, SOC may go lower than the limit if the battery can't get charged for a long period of time.

- * ForceCharge SOC (5%~OverDischg SOC, default 10%)

- To prevent the battery going into sleep mode, when the ForceCharge SOC is reached, inverter will charge the battery using the power from either PV or Grid.

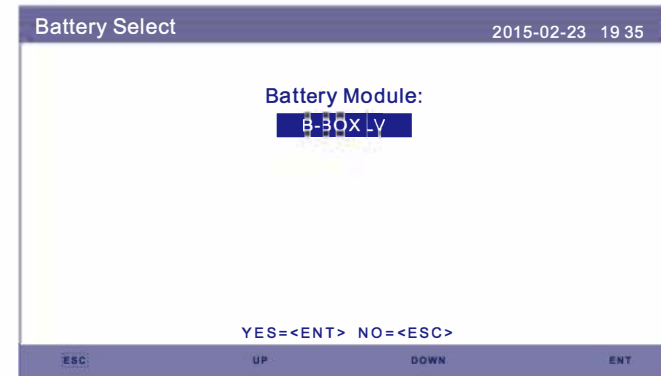

Figure 5.33 Battery Select

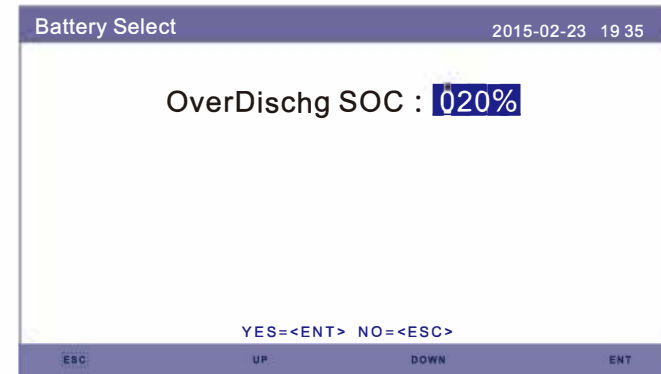

Figure 5.34 Over Discharge SOC.

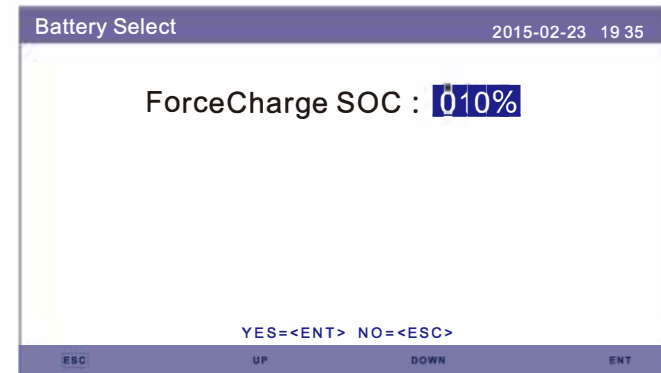
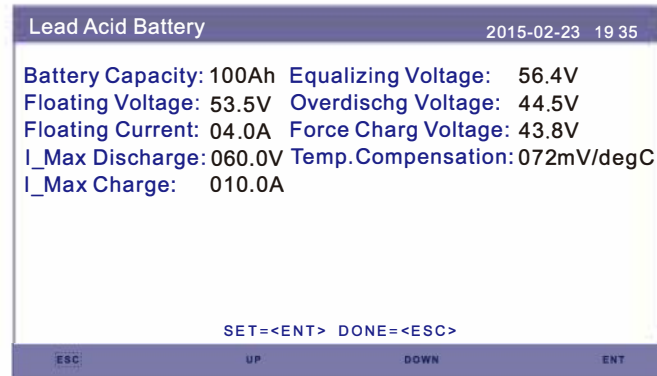

Figure 5.35 ForceCharge SOC



NOTE:

5G products support lead-acid battery. Select "Lead-Acid" in the "Battery Select" and configure the following parameters according to different lead-acid batteries.



Lead Acid Battery (Values are examples Only)

1. Battery Capacity: Define the capacity of the battery.
2. Equalizing Voltage: Define the voltage for equalizing charge.
3. Floating Voltage: Define the voltage for floating charge.
4. Floating Current: Define the current for floating charge.
5. Overdischg Voltage: Define the voltage that stops discharging the battery.
6. Force Charg Voltage: Define the voltage that forces to charge the battery to prevent a dead battery.
7. I_Max Discharge: Define the max discharge current for the battery.
8. I_Max Charge: Define the max charge current for the battery.
9. Temp.Compensation: Define the temperature compensation parameter for the battery.

After configuration, save and send. Select the Environment Temp based on real condition.(Hot/Warm/Cold)

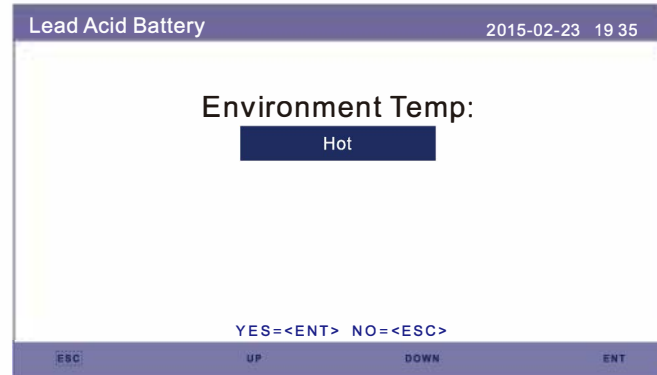

WARNING:

Lead-acid battery is not recommended for general customers as it requires experienced installers and technicians who can fully understand the battery parameters and configure the settings and installations correctly. Due to the inconformity between battery cells, damages will be less likely to be avoided. Solis is not responsible for any potential damages caused by the use of lead-acid batteries.

5.6.6.3 Meter Set

These settings are used to select the meter types and meter installed locations based on the actual configuration.

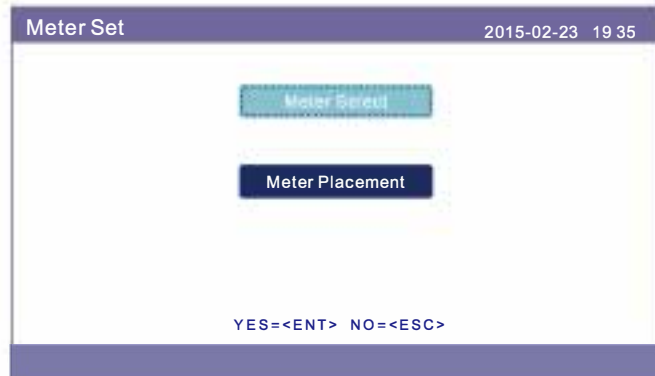

Figure 5.36 Meter Set

5.6.6.3.1 Meter Select

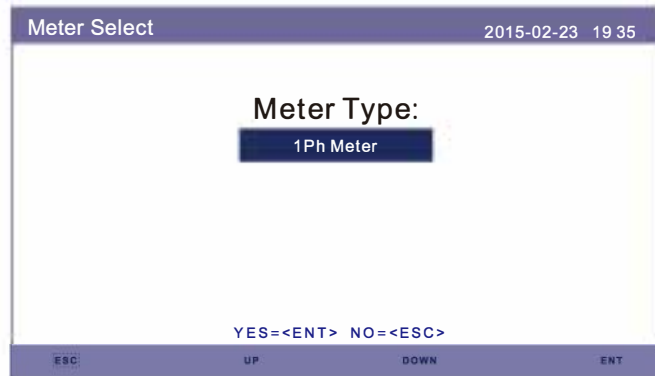

Figure 5.37 Meter Select

Meter Model	Meter Type Options
Acrel 1ph meter (With CT): ACR10R-D16TE	"1ph meter"
Acrel 3ph meter (With CT): ACR10R-D16TE4 (Optional)	"Acrel 3ph meter"
Eastron 1ph meter (Direct Insert): SDM120M	"Eastron 1ph meter"
Eastron 1ph meter (With CT): SDM120CTM (Optional)	"Eastron 1ph meter"
Eastron 3ph meter (Direct Insert): SDM630M (Optional)	"Eastron 3ph meter"
Eastron 3ph meter (With CT): SDM630MCT (Optional)	"Eastron 3ph meter"
No meter is connected	"No Meter"

5.6.6.3.2 Meter Placement

Grid: Meter is installed at the grid connection point.

Load: Meter is installed at the load branch circuit.

Grid+PV Inverter: One meter is connected at the grid connection point, the other meter is connected at the AC output port of an extra PV inverter. (Eastron Meter supported).



Figure 5.38 Meter Placement

5.6.6.4 Storage Mode Select

There are 5 working modes available.

1. Self Use Mode
2. Feed in Priority Mode
3. Backup Mode
4. Off Grid Mode
5. EPS Mode

Only 1 mode can be enabled at the same time.

Please refer to Appendix 9.4 for explanations and setting instructions for each mode.

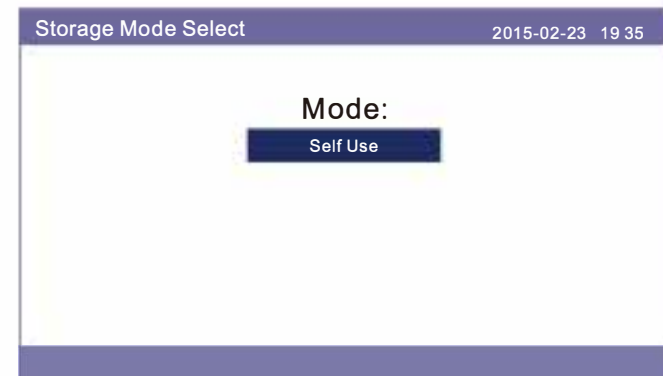

Figure 5.39 Storage Mode Select

5.6.6.5 Battery Wakeup

This function should be activated only after the installation. In the case of a low battery voltage shutdown, the inverter will shut-down. This setting can be enabled, so when the inverter detects PV or grid it wakes up the battery. This function conflicts with the battery reverse polarity protection(If the installer connects cables with wrong polarity, the inverter can protect itself from damage).To avoid the possible damage during installation, do not active battery wakeup function before finishing the first commissioning.

5.6.7 Export power Set

This function is to set the export power control.

1.Backflow Power. 2. ON/OFF. 3.FailSafe ON/OFF

Setting 1&3 are only valid when Setting 2 is set to "ON"

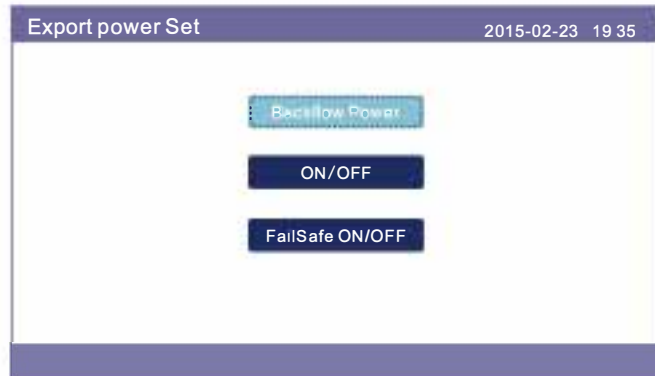

Figure 5.44 Export power Set

5.6.7.1 Backflow Power

Determine the allowed backfeed power. (System export to the grid)

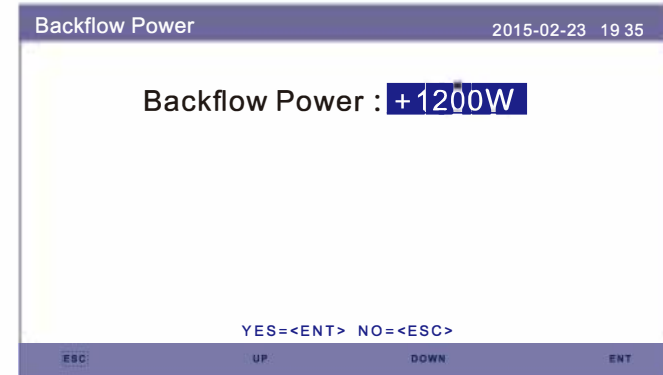

Figure 5.45 Backflow Power

5.6.7.2 ON/OFF

Enable/Disable the function.



Figure 5.46 ON/OFF

5. Operation

5.6.7.3 FailSafe ON/OFF

When this Failsafe function is ON, the inverter will shutdown once it loses communication with the meter in case of any backflow power exceeding the limit.

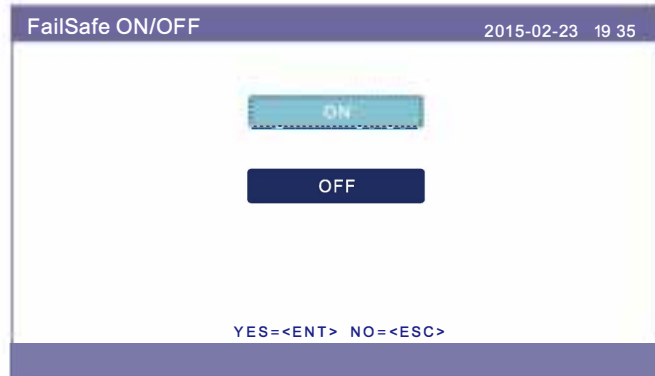

Figure 5.47 FailSafe ON/OFF

5.6.8 HMI Update

This function is used to update HMI software.
Values are for reference only.

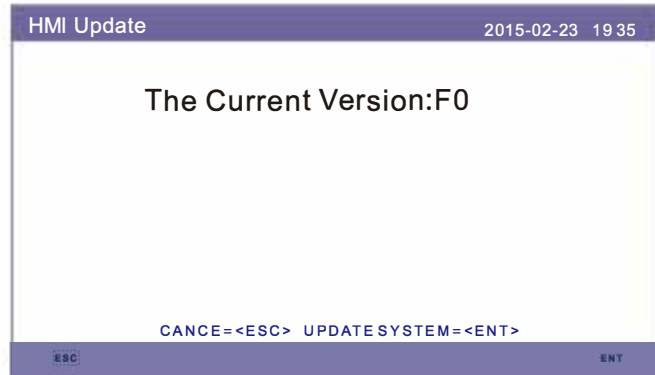

Figure 5.48 HMI Update

5. Operation

5.6.9 DSP Update

This function is used to update DSP software.
Values are for reference only.

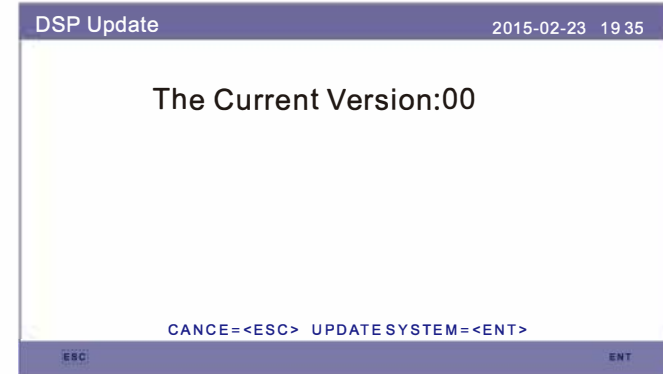

Figure 5.49 DSP Update

5.6.10 BaudRate RS485

This function is to change the internal communication Baudrate.

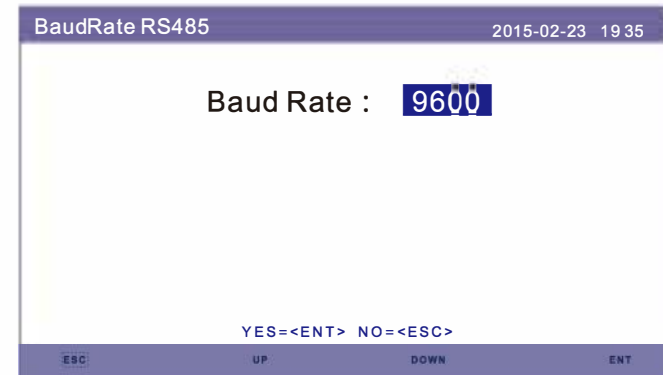

Figure 5.50 BaudRate RS485



WARNING:

This function is for maintenance personnel only, wrong operation will prevent the inverter from working properly.

5.7 AFCI function

Inverters have the built-in AFCI function which can detect the arc fault on the DC circuit and shut down the inverter to prevent a fire disaster.

5.7.1 Enable the AFCI function

The AFCI function can be enabled in the following.

Path: **Advanced Setting -> Password: 0010 -> AFCI Set -> AFCI ON/OFF -> ON**



NOTE:

If you find your inverters's user interface is different from what's in the fast installation guide, please contact after-sales engineer or technical support.



WARNING:

The "AFCI Level" is reserved for technicians ONLY. Do not change the sensitivity otherwise it will lead to frequent false alarms or malfunctions. Manufacturer is not responsible for any further damages caused by unauthorized modifications.



WARNING:

The setting corresponds to the current status as well which can be used to inspect the ON/OFF state of the AFCI function.

5.7.2 Arc Fault

During the normal operation, if a DC arc is detected, the inverter will shut down and give out the following alarm:



Installer needs to thoroughly inspect the DC circuit to ensure all the cables are correctly fastened.

Once the DC circuit issue has been fixed or it is confirmed to be OK, press "ESC" for 3s and wait for the inverter to restart.

6. Commissioning

6.1 Preparation of Commissioning

- Ensure all the devices are accessible for operation, maintenance and service.
- Check and confirm that the inverter is firmly installed.
- Space for ventilation is sufficient for one inverter or multiple inverters.
- Nothing is left on the top of the inverter or battery module.
- Inverter and accessories are correctly connected.
- Cables are routed in safe place or protected against mechanical damage.
- Warning signs and labels are suitably affixed and durable.

6.2 Commissioning Procedure

If all the items mentioned above meet the requirements, proceed as follows to start up the inverter for the first time.

1. Turn on inverter DC switch
2. Turn on battery breaker or battery switch button on the battery.
3. Select the grid standard code.
4. Configure the parameters.
5. Switch on AC backup and AC grid.
6. Verify inverter initializing.

6.3 Shutdown procedure

1. Turn off the AC isolator at the grid connection point.
2. Turn off the DC switch of the inverter.
3. Turn off the DC switch between inverter and battery.
4. Waiting for the LCD of inverter to turn off and the system shutdown is completed.

7. Maintenance

Solis RHI-5G Series inverter does not require any regular maintenance. However, cleaning the heatsink will help inverter dissipating heat and increase the lifetime of inverter. The dirt on the inverter can be cleaned with a soft brush.



CAUTION:

Do not touch the surface when the inverter is operating. Some parts may be hot and cause burns. Turn OFF the inverter (refer to Section 6.2) and let it cool down before you do any maintenance or cleaning of inverter.

The LCD and the LED status indicator lights can be cleaned with cloth if they are too dirty to be read.



Note:

Never use any solvents, abrasives or corrosive materials to clean the inverter.

8. Troubleshooting

The inverter has been designed in accordance with international grid tied standards for safety, and electromagnetic compatibility requirements. Before delivering to the customer the inverter has been subjected to several test to ensure its optimal operation and reliability.

In case of a failure the LCD screen will display an alarm message. In this case the inverter may stop feeding energy into the grid. The alarm descriptions and their corresponding alarm messages are listed in Table 8.1:

When faults occur, the "Fault" state will be shown on the main screen.

Follow the steps below to check what fault occurs.

Steps: Enter → Down → Advanced Information → Enter → Alarm Message.

Step1: Press ENTER.

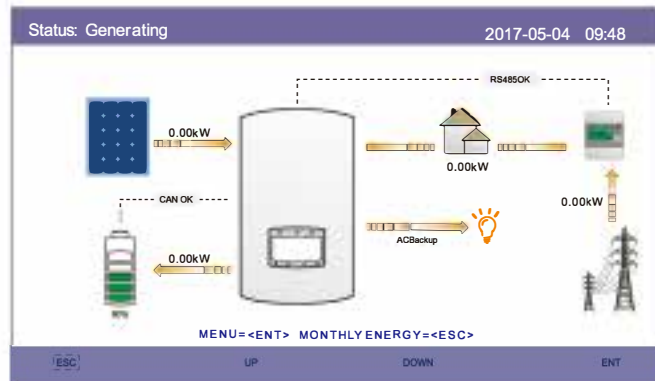

Step2: Press DOWN to select Advanced Information, then press ENTER.

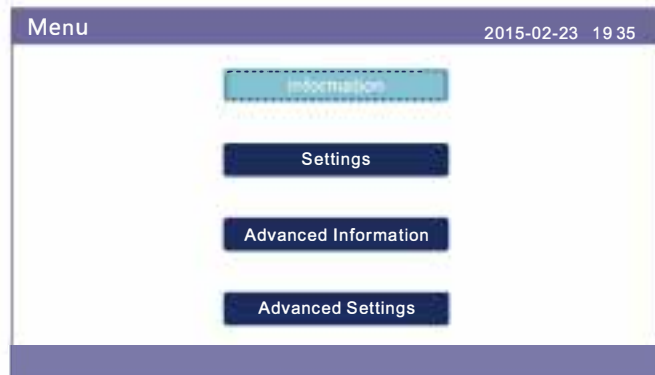

8. Troubleshooting

Step3: Press DOWN to select Alarm Message, then press ENTER.

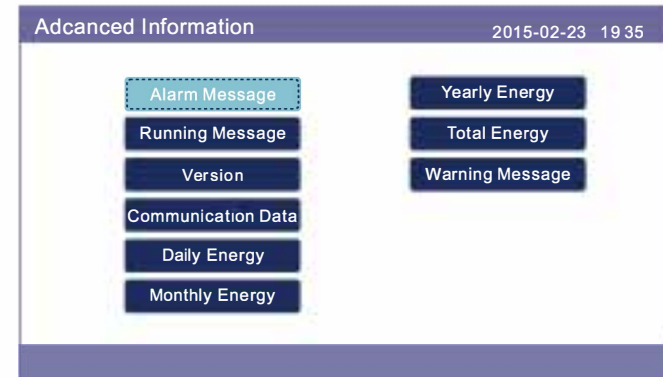

8. Troubleshooting

Alarm Message	Failure description	Solution
ARC-FAULT	ARC detected in DC circuit	1. Check if there's arc in PV connection and restart inverter.
AFCI Check FAULT	AFCI module self check fault	1. Restart inverter or contact installer.
DCinj-FAULT	High DC injection current	1. Restart inverter or contact installer.
DSP-B-FAULT	Comm. failure between main and slave DSP	1. Restart inverter or contact installer.
DC-INTF	DC input overcurrent	1. Restart inverter. 2. Identify and remove the string to the fault MPPT. 3. Change power board.
G-IMP	High grid impedance	1. Use user define function to adjust the protection limit if it's allowed by electrical company.
GRID-INTF01/02	Grid interference	1. Restart inverter. 2. Change power board.
IGBT-OV-I	Over IGBT current	
IGFOL-F	Grid current tracking fail	1. Restart inverter or contact installer.
IG-AD	Grid current sampling fail	
ILeak-PRO 01/02/03/04	leakage current protection	1. Check AC and DC connection. 2. Check inverter inside cable connection.
INI-FAULT	Initialization system fault	1. Restart inverter or contact installer.
LCD show initializing all the time	Can not start-up	1. Check if the connector on main board or power board are fixed. 2. Check if the DSP connector to power board are fixed.
NO-Battery	Unconnected battery	1. Check the wire of battery power is connected correctly or not. 2. Check the output voltage of battery is correctly or not.
No power	Inverter no power on LCD	1. Check PV input connections. 2. Check DC input voltage (single phase >120V, three phase >350V). 3. Check if PV+/- is reversed.
NO-GRID	No grid voltage	1. Check connections and grid switch. 2. Check the grid voltage inside inverter terminal.
OV-BUS	Over DC bus voltage	1. Check inverter inductor connection. 2. Check driver connection.

8. Troubleshooting

Alarm Message	Failure description	Solution
OV-DC01/02/03/04	Over DC voltage	1. Reduce the module number in series.
OV-DCA-I	DC input overcurrent	1. Restart inverter. 2. Identify and remove the string to the fault MPPT. 3. Change power board.
OV-G-V01/02/03/04	Over grid voltage	1. Resistant of AC cable is too high. Change bigger size grid cable. 2. Adjust the protection limit if it's allowed by electrical company.
OV-G-I	Over grid current	1. Restart inverter. 2. Change power board.
OV-G-F01/02	Over grid frequency	1. Use user define function to adjust the protection limit if it's allowed by electrical company.
OV-IgTr	AC side transient overcurrent	1. Restart inverter. 2. Return-factory repair.
OV-ILLC	LLC hardware overcurrent	
OV-VBackup	Backup overvoltage fault	
OV-TEM	Over Temperature	1. Check inverter surrounding ventilation. 2. Check if there's sunshine direct on inverter in hot weather.
OV-Vbatt1	The detection of battery overvoltage	1. Check the protect point for over voltage sets correctly or not. 2. Restart inverter.
OV-Vbatt-H	Battery overvoltage hardware fault	1. Check the circuit whether the battery circuit jumps. 2. Restart inverter.
Over-Load	Backup overload fault	1. Check the load of Backup port is over rating output power or not. 2. Reduce the load of Backup port, then restart inverter.
PV ISO-PRO01/02	PV isolation protection	1. Remove all DC input, reconnect and restart inverter one by one. 2. Identify which string cause the fault and check the isolation of the string.
RelayChk-FAIL	Relay check fail	1. Restart inverter or contact installer.

8. Troubleshooting

Alarm Message	Failure description	Solution
UN-BUS01/02	Under DC bus voltage	1. Check inverter inductor connection. 2. Check driver connection.
UN-G-F01/02	Under grid frequency	1. Use user define function to adjust the protection limit if it's allowed by electrical company.
UN-G-V01/02	Under grid voltage	
12Power-FAULT	12V power supply fault	1. Restart inverter or contact installer.
AFCI self-detection (model with AFCI module)	AFCI module self-detect fault	1. Restart inverter or connect technician.
Arcing protection (model with AFCI module)	Detect arc in DC circuit	1. Check inverter connection whether arc exists and restart inverter.

Table 8.1 Fault message and description



NOTE:

If the inverter displays any alarm message as listed in Table 8.1; please turn off the inverter and wait for 5 minutes before restarting it. If the failure persists, please contact your local distributor or the service center.

Please keep ready with you the following information before contacting us.

1. Serial number of Solis Single Phase Inverter;
2. The distributor/dealer of Solis Single Phase Inverter (if available);
3. Installation date.
4. The description of problem (i.e. the alarm message displayed on the LCD and the status of the LED status indicator lights. Other readings obtained from the Information submenu (refer to Section 6.2) will also be helpful.);
5. The PV array configuration (e.g. number of panels, capacity of panels, number of strings, etc.);
6. Your contact details.

9. Specifications

Technical Data	RHI-3K-48ES-5G	RHI-3.6K-48ES-5G
Input DC (PV side)		
Recommended max. PV power	7000W	
Max. input voltage	600V	
Rated voltage	330V	
Start-up voltage	120V	
MPPT voltage range	90-520V	
Full load MPPT voltage range	141-520V	169-520V
Max. input current	11A/11A	
Max. short circuit current	17.2A/17.2A	
MPPT number/Max input strings number	2/2	
Battery		
Battery Type	Li-ion / Lead-acid	
Battery Voltage range	42 - 58V	
Battery Capacity	50 - 2000Ah	
Maximum Charging Power	3kW	
Maximum Charge/discharge current	62.5A	
Communication	CAN	
Output AC(Back-up)		
Rated output power	3kW	
Max. apparent output power	4kVA	
Back-up switch time	<20ms	
Rated output voltage	1/N/PE, 220 V/230 V	
Rated frequency	50/60Hz	
Rated output current	13.6A/13A	
THDv(@linear load)	2%	
Input AC (Grid side)		
Input voltage range	184-264V	
Max. input current	26.1A	
Frequency range	45-55 Hz/ 55-65Hz	

9. Specifications

Output AC(Grid side)		
Rated output power	3kW	3.6kW
Max. apparent output power	3.3kVA	4kVA
Operation phase	1/N/PE	
Rated grid voltage	220 V/230 V	
The grid voltage range	187-265 V	
Rating grid frequency	50/60 Hz	
AC grid frequency range	47-52 Hz/57-62 Hz	
Rating grid output current	13.6A/13A	16.3A/15.7A
Max. output current	15.7A	17.3A
Power Factor	>0.99 (0.8 leading - 0.8 lagging)	
THDi	<2%	
Efficiency		
Max efficiency	>97.5%	
EU efficiency	>96.8%	
Protection		
Ground fault monitoring	Yes	
Residual current monitoring unit	Yes	
Integrated AFCI (DC arc-fault circuit protection)	Yes	
DC reverse polarity protection	Yes	
Protection class/Over voltage category	I/II	

9. Specifications

General data	
Dimensions(W/H/D)	333*505*249mm
Weight	17kg
Topology	High frequency insulation (for battery)
Operation temperature range	-25°C ~ +60°C
Ingress protection	IP65
Noise emission	<20 dB (A)
Cooling concept	Natural convection
Max.operation altitude	2000m
Grid connection standard	G98 or G99, VDE-AR-N 4105 / VDE V 0124, EN 50549-1, VDE 0126 / UTE C 15 / VFR:2019, RD 1699 / RD 244 / UNE 206006 / UNE 206007-1, CEI 0-21, C10/11, NRS 097-2-1, TOR, EIFS 2018.2, IEC 62116, IEC 61727, IEC 60068, IEC 61683, EN 50530, MEA, PEA
Safety/EMC standard	IEC/EN 62109-1/-2, EN 61000-6-2/-3
Features	
DC connection	MC4 connector
AC connection	Quick connection plug
Display	7.0"LCD color screen display
Communication	RS485, Optional:Wi-Fi, GPRS
Warranty	5 years standard (extend to 20 years)

9. Specifications

Technical Data	RHI-4.6K-48ES-5G	RHI-5K-48ES-5G
Input DC (PV side)		
Recommended max. PV power	8000W	
Max. input voltage	600V	
Rated voltage	330V	
Start-up voltage	120V	
MPPT voltage range	90-520V	
Full load MPPT voltage range	215-520V	234-520V
Max. input current	11A/11A	
Max. short circuit current	17.2A/17.2A	
MPPT number/Max input strings number	2/2	
Battery		
Battery Type	Li-ion / Lead-acid	
Battery Voltage range	42 - 58V	
Battery Capacity	50 - 2000Ah	
Maximum Charging Power	5kW	
Maximum Charge/discharge current	100A	
Communication	CAN	
Output AC(Back-up)		
Rated output power	5kW	
Max. apparent output power	6kVA	
Back-up switch time	<20ms	
Rated output voltage	1/N/PE, 220 V/230 V	
Rated frequency	50/60Hz	
Rated output current	22.7/22A	
THDv(@linear load)	2%	
Input AC (Grid side)		
Input voltage range	184-264V	
Max. input current	26.1A	
Frequency range	45-55 Hz/ 55-65Hz	

9. Specifications

Output AC(Grid side)		
Rated output power	4.6kW	5kW
Max. apparent output power	4.6kVA	5.5kVA*
Operation phase	1/N/PE	
Rated grid voltage	220 V/230 V	
The grid voltage range	187-265 V	
Rating grid frequency	50/60 Hz	
AC grid frequency range	47-52 Hz/57-62 Hz	
Rating grid output current	20.9A/20A	22.7A/21.7A
Max. output current	23.0A	23.9A
Power Factor	>0.99 (0.8 leading - 0.8 lagging)	
THDi	<2%	
Efficiency		
Max efficiency	>97.5%	
EU efficiency	>96.8%	
Protection		
Ground fault monitoring	Yes	
Residual current monitoring unit	Yes	
Integrated AFCI (DC arc-fault circuit protection)	Yes	
DC reverse polarity protection	Yes	
Protection class/Over voltage category	I/II	

9. Specifications

General data	
Dimensions(W/H/D)	333*505*249mm
Weight	17kg
Topology	High frequency insulation (for battery)
Operation temperature range	-25°C ~ +60°C
Ingress protection	IP65
Noise emission	<20 dB (A)
Cooling concept	Natural convection
Max.operation altitude	2000m
Grid connection standard	G98 or G99, VDE-AR-N 4105 / VDE V 0124, EN 50549-1, VDE 0126 / UTE C 15 / VFR:2019, RD 1699 / RD 244 / UNE 206006 / UNE 206007-1, CEI 0-21, C10/11, NRS 097-2-1, TOR, EIFS 2018.2, IEC 62116, IEC 61727, IEC 60068, IEC 61683, EN 50530, MEA, PEA
Safety/EMC standard	IEC/EN 62109-1/-2, EN 61000-6-2/-3
Features	
DC connection	MC4 connector
AC connection	Quick connection plug
Display	7.0"LCD color screen display
Communication	RS485, Optional:Wi-Fi, GPRS
Warranty	5 years standard (extend to 20 years)

*For Belgium market, the max apparent output power is 5kVA.

9. Specifications

Technical Data	RHI-6K-48ES-5G*
Input DC (PV side)	
Recommended max. PV power	8000W
Max. input voltage	600V
Rated voltage	330V
Start-up voltage	120V
MPPT voltage range	90-520V
Full load MPPT voltage range	280-520V
Max. input current	11A/11A
Max. short circuit current	17.2A/17.2A
MPPT number/Max input strings number	2/2
Battery	
Battery Type	Li-ion / Lead-acid
Battery Voltage range	42 - 58V
Battery Capacity	50 - 2000Ah
Maximum Charging Power	5kW
Maximum Charge/discharge current	100A
Communication	CAN
Output AC(Back-up)	
Rated output power	5kW
Max. apparent output power	6kVA
Back-up switch time	<20ms
Rated output voltage	1/N/PE, 220 V/230 V
Rated frequency	50/60Hz
Rated output current	22.7A/22A
THDv(@linear load)	2%
Input AC (Grid side)	
Input voltage range	184-264V
Max. input current	26.1A
Frequency range	45-55 Hz/ 55-65Hz

9. Specifications

Output AC(Grid side)	
Rated output power	6kW
Max. apparent output power	6kVA
Operation phase	1/N/PE
Rated grid voltage	220 V/230 V
The grid voltage range	187-265 V
Rating grid frequency	50/60 Hz
AC grid frequency range	47-52 Hz/57-62 Hz
Rating grid output current	27.2A/26.1A
Max. output current	26.1A
Power Factor	>0.99 (0.8 leading - 0.8 lagging)
THDi	<2%
Efficiency	
Max efficiency	>97.5%
EU efficiency	>96.8%
Protection	
Ground fault monitoring	Yes
Residual current monitoring unit	Yes
Integrated AFCI (DC arc-fault circuit protection)	Yes
DC reverse polarity protection	Yes
Protection class/Over voltage category	I/II

9. Specifications

General data	
Dimensions(W/H/D)	333*505*249mm
Weight	17kg
Topology	High frequency insulation (for battery)
Operation temperature range	-25°C ~ +60°C
Ingress protection	IP65
Noise emission	<20 dB (A)
Cooling concept	Natural convection
Max.operation altitude	2000m
Grid connection standard	G98 or G99, VDE-AR-N 4105 / VDE V 0124, EN 50549-1, VDE 0126 / UTE C 15 / VFR:2019, RD 1699 / RD 244 / UNE 206006 / UNE 206007-1, CEI 0-21, C10/11, NRS 097-2-1, TOR, EIFS 2018.2, IEC 62116, IEC 61727, IEC 60068, IEC 61683, EN 50530, MEA, PEA
Safety/EMC standard	IEC/EN 62109-1/-2, EN 61000-6-2/-3
Features	
DC connection	MC4 connector
AC connection	Quick connection plug
Display	7.0"LCD color screen display
Communication	RS485, Optional:Wi-Fi, GPRS
Warranty	5 years standard (extend to 20 years)

*This model is not available in Belgium.

10.1 Battery Terminal Assembly

In order to avoid DC arc, Solis suggest to install a DC switch between the battery and RHI inverter.

- Make sure the polarities of battery is correct before connecting to the inverter;
- Please follow the instructions below to choose the battery power cable.



NOTE:

Power cable uses water-proofed AMPHENOL connectors. It must keep pressing this Lock Button during pulling out the power plug.

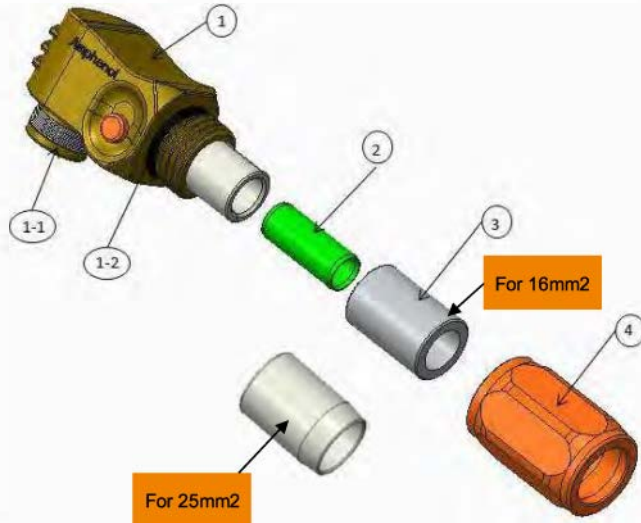

①: Connector Body

1-1: Barrel sealing (Not included when no sealing requirement)

1-2: O-Ring (Not included when no sealing requirement)

②: Barrel (Only for cable size 16mm²)

③: Grommet (Not included when no sealing requirement)

④: Back Shell

Step 1: Wire cutting and stripping (Apply for 10mm² & 16mm² Cable)

Stripping conductor: 18±1mm

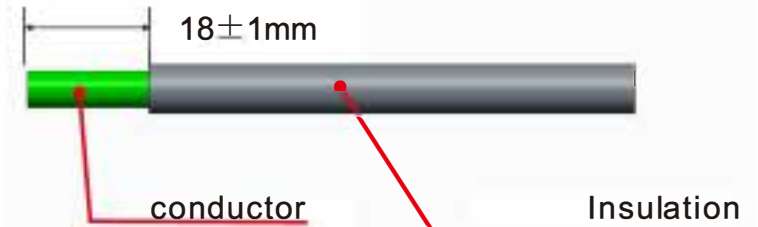

Step 2: Un-assemble item 3&4 over the cable as shown

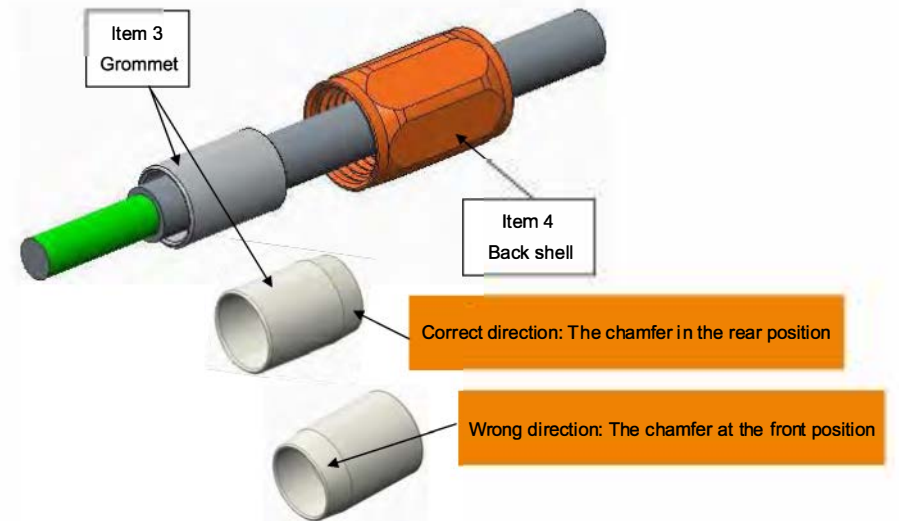

Step 3: Put the barrel and the cable conductor into the lug

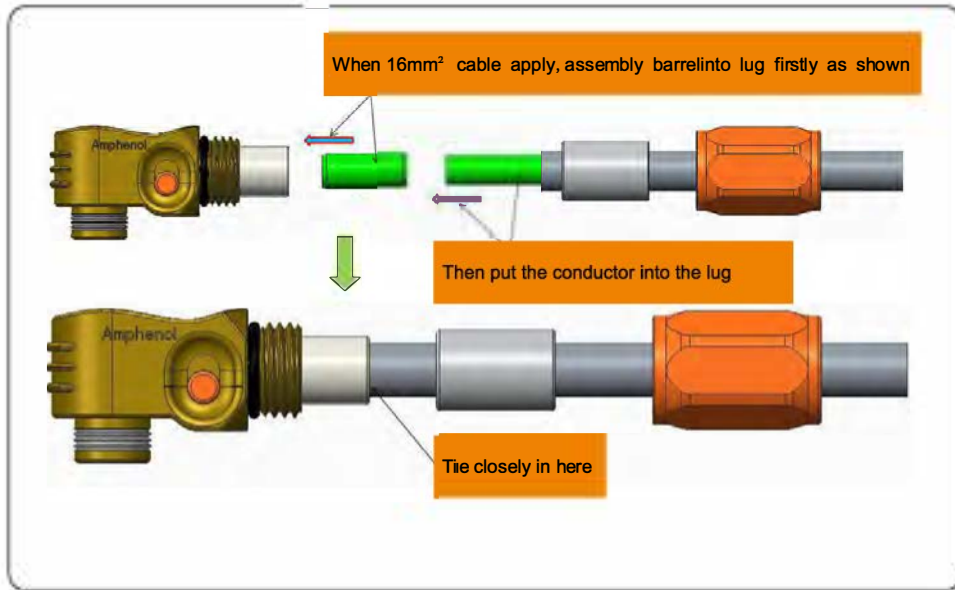

Step 4: Crimping the lug as shown

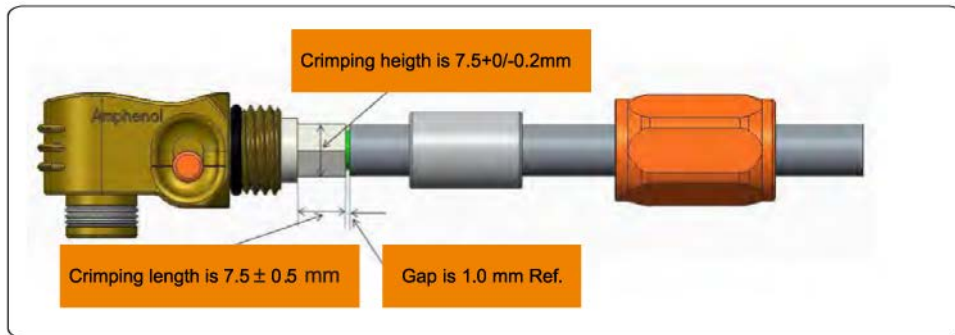

Cable size	Cable range	Crimping height	Cable pullout force
16 mm ²	8.10±0.20 mm	7.5+0/-0.2mm	1000N Min.
25 mm ²	10.20±0.20 mm		1200N Min.

Recommended crimping tool: Manual hydraulic crimping

Die: 25 mm²



Step 5: Install grommet and back shell

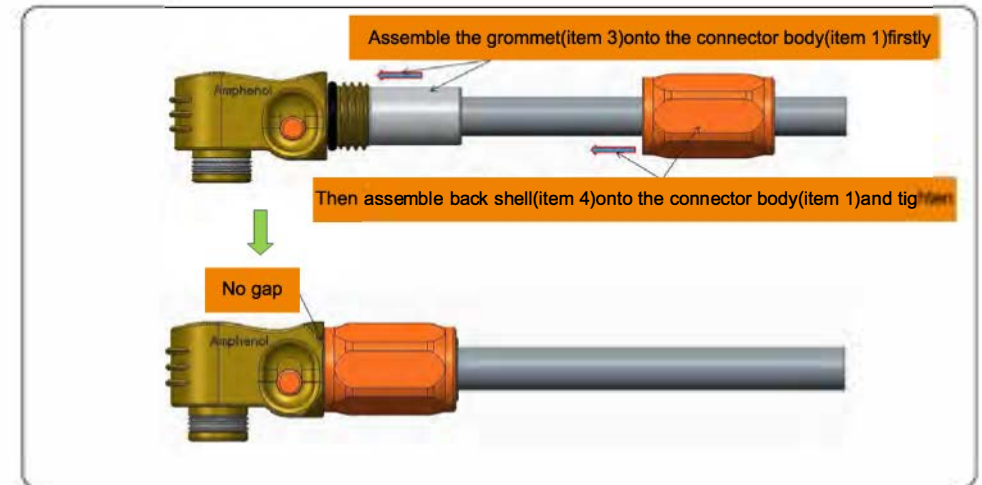

10. Appendix

10. Appendix

10.2 Three phase meter connection

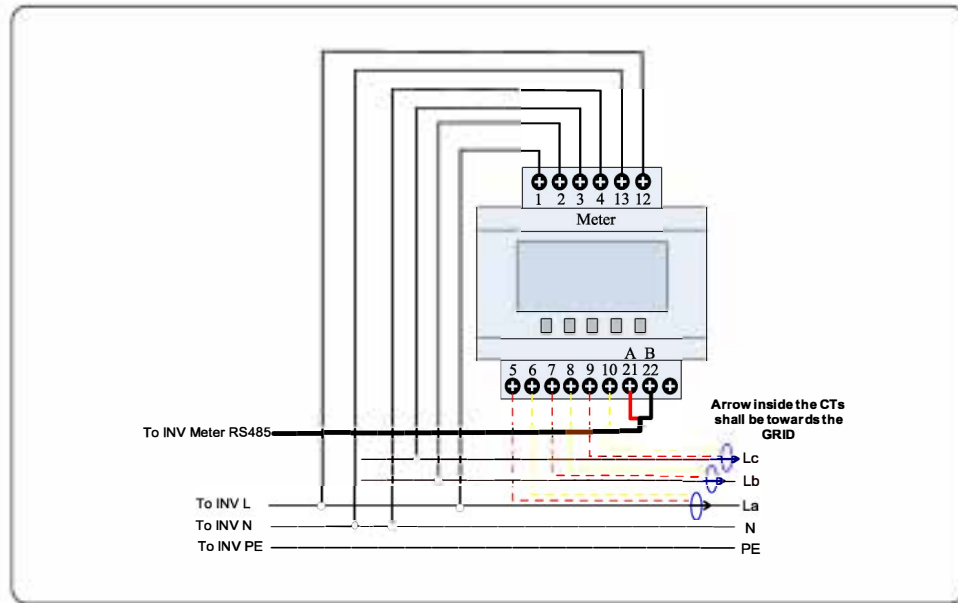

10.3 Special Back-up Connection

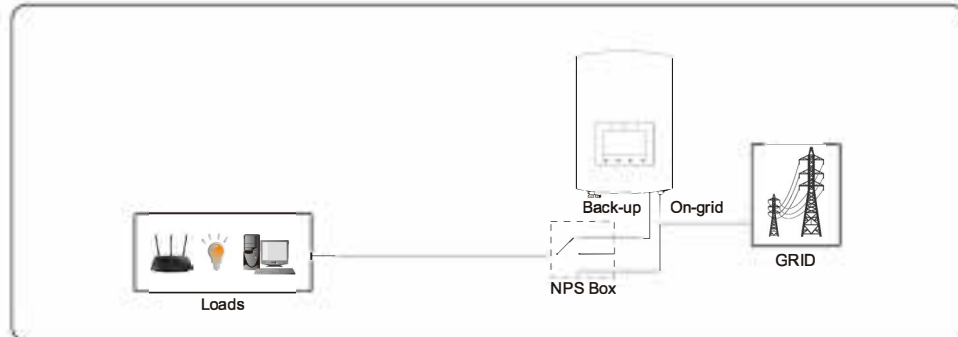

For some markets such as Italy, etc., the backup port and grid port should not be powered at the same time.

When the grid is present, the grid port should be used to support the loads.

When the grid is lost, the backup port should be used to support the loads.

An interlocking function between the backup port and grid port is necessary.

Therefore, a separate NPS box and firmware upgrade is needed to achieve this function.

Please consult Solis technicians for details and refer to the NPS box installation manual

10.4 Working Mode Description

Mode 1: Self-Use Mode Logic(Maximize the usage of PV)

PV Power Using Priority: Load>Battery>Grid

Load Support Priority: PV>Battery>Grid

Battery Charging Power comes from PV. (If "Charging From Grid" is allowed, it can also come from Grid)

If "Time of Use" is "Run", the logic will follow the charging/discharging settings and time settings as defined in "Time of Use". For those undefined period of time, it will still follow the Self-Use logic.

Time of use for Self use

Path: Advanced Settings-> Storage Energy Set-> Storage Mode Select-> Self-Use Mode-> ON-> Time of use for Self use

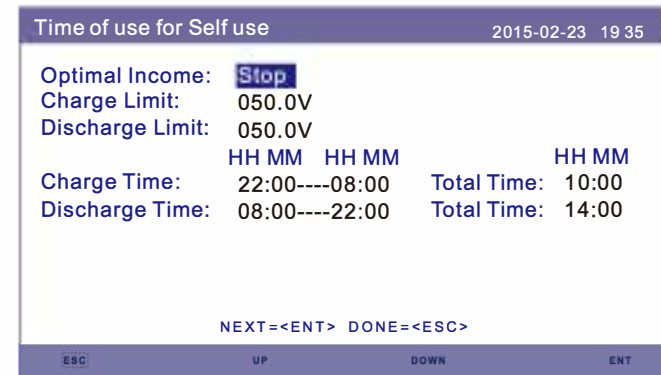

Charging from grid self use

Path: Advanced Settings-> Storage Energy Set-> Storage Mode Select-> Self-Use Mode-> ON-> Charging from grid for Self use



Mode 2: Feed In Priority Mode Logic(Feed the excess PV to Grid in order to gain s subsidies)

PV Power Using Priority: Load>Grid>Battery

Load Support Priority: PV>Battery>Grid

Battery Charging Power comes from PV. (If "Charging From Grid" is allowed, it can also come from Grid)

If "Time of Use" is "Run", the logic will follow the charging/discharging settings and time settings as defined in "Time of Use". For those undefined period of time, it will still follow the Feed in Priority logic.

Time of use for Feed for priority

Path: Advanced Settings-> Storage Energy Set-> Storage Mode Select->

Feed in Priority Mode->ON->Time of use for Feed for priority

Time of use for Feed for priority 2015-02-23 19 35

Optimal Income: Stop
 Charge Limit: 050.0V
 Discharge Limit: 050.0V

	HH MM	HH MM	HH MM
Charge Time:	22:00	08:00	Total Time: 10:00
Discharge Time:	08:00	22:00	Total Time: 14:00

NEXT=<ENT> DONE=<ESC>

ESC UP DOWN ENT

Charging from gird for Feed for priority

Path: Advanced Settings-> Storage Energy Set-> Storage Mode Select->

Feed in Priority Mode->ON->Charging from gird for Feed for priority

Charging from gird for Feed for priority 2015-02-23 19 35

Allow

Not Allow

YES=<ENT> NO=<ESC>

Mode 3: Backup Mode Logic(Keep the Battery at a certain SOC and only use it during power outage)

Backup Mode Logic: Keep the Battery at a certain SOC and only use it during power outage.

Backup SOC Setting Range: From Battery "Overdischarge SOC" to 100%

PV Power Using Priority: Battery>Load>Grid

Load Support Priority: PV>Grid>Battery

Battery Charging Power comes from PV. (If "Charging From Grid" is allowed, it can also come from Grid)

* The "Backup Mode" is not applicable for Lead-acid batteries.

Charging from gird for Backup mode

Path: Advanced Settings-> Storage Energy Set-> Storage Mode Select-> Backup Mode->

ON-> Backup SOC-> Charging from gird for Backup mode

Charging from gird for Backup mode 2015-02-23 19 35

Allow

Not Allow

YES=<ENT> NO=<ESC>

Mode 4: Off-Grid Mode Logic(For Off-grid use and AC-Grid Port Disconnected)

OverDischg SOC for Off-Grid Setting Range: From Battery "Forcecharge SOC" to 100%

PV Power Using Priority: Load>Battery

Load Support Priority: PV>Battery

Battery Charging Power comes from PV.

Off Grid Mode

Path: Advanced Settings->Storage Energy Set->Storage Mode Select->Off-Grid Mode->

ON->Off Grid Mode

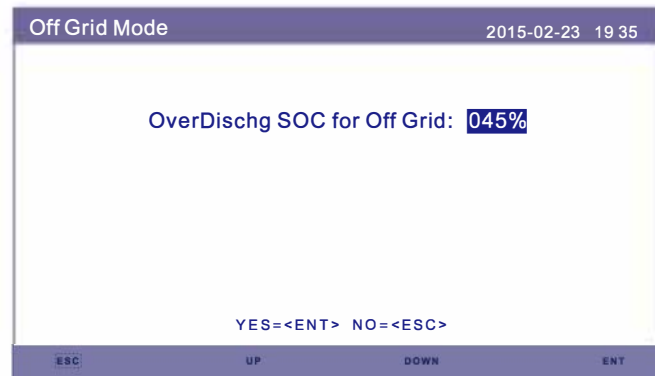

Mode 5: EPS Mode Logic(Need to work with external Solis NPS switching Box to achieve switching function)

When grid is available, only the Grid Port is enabled and load is supported through NPS box by the grid.

When grid is lost, Grid Port will be disabled and after the "Switching Time", the Backup Port will be enabled and then load is supported through NPS box by the Backup Port.

*It gives up the UPS function of the backup port and manually set the switching time.

This mode must work with the Solis NPS switching Box.

Otherwise it may cause some unexpected control mistakes.

EPS Mode

Path: Advanced Settings->Storage Energy Set->Storage Mode Select->EPS Mode->

EPS En/Disable->Enable

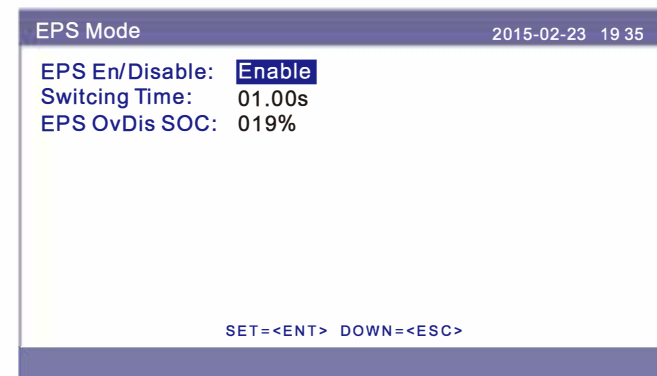

10.5 Grid standard selection guide



NOTE:

Please check if the grid code setting comply with local requirement.

For different countries and regions, corresponding grid code needs to be selected in the inverter LCD to meet the requirements of local network provider.

This instruction indicates how to change the grid code and what code should be selected in different places.

This following list illustrates the grid standard options in the inverter which are subject to change. It is for your reference only. If customer has any doubts or uncertainty, please consult Solis service department for confirmation.

To set the correct grid code, please enter the following path:

Advanced Settings -> Password:0010 -> Select Standard

Detailed protection limits can be viewed when choosing the code.

Please select "Save&Send" to enforce the code.

NO.	Code in LCD	Country/Region	Comments
1	VDE4015	Germany	For German Low Voltage Grid.
2	EN50549 PO	Poland	For Polish Low Voltage Grid
3	EN50549 NL	Netherland	For Dutch Low Voltage Grid
4	EN50438 L	-	General EN50438 Requirement. Possible to be used in Austria, Cyprus, Finland, Czech Republic, Slovenia, etc.
5	EIFS- SW	Sweden	For Swedish Low Voltage Grid
6	France	France	For French Low Voltage Grid
7	C10/11	Belgium	For Belgian Low Voltage Grid
8	NRS097	South Africa	For South African Low Voltage Grid
9	CEI0-21	Italy	For Italian Low Voltage Grid
10	EN50549L (EN50549-1)	-	General EN50549-1 requirement which meets local requirements of most European countries
11	G98	UK	For UK Low Voltage Grid <16A
12	G99	UK	For UK Low Voltage Grid >16A

NO.	Code in LCD	Country/Region	Comments
13	G98 NI	North Ireland	For North Ireland Low Voltage Grid <16A
14	G99 NI	North Ireland	For North Ireland Low Voltage Grid >16A
15	User-define	-	Customized Protection Limits
16	Gen50	-	Generator Connected, Frequency-Derating, 50Hz
17	Gen 60	-	Generator Connected, Frequency-Derating, 60Hz
18	DK1	East Denmark	For East Danish low voltage grid
19	DK2	West Denmark	For West Danish low voltage grid
20	50438IE	Ireland	For Irish low voltage grid
21	RD1699	Spain	For Spanish low voltage grid
22	EN50549 L	-	General EN50549 Requirement. Possible to be used in Cyprus, Finland, Czech Republic, Slovenia, Jamaica